



Cement Equipment Product Guidebook

CAT.No.8026/E



NTN provides a range of products suited for the cement manufacturing process.

NTN products are utilized in a diverse range of machinery used with raw materials, and firing and finishing processes. Products are available that can provide a long service life under dust, high-load and high-temperature environments, which contributes to reductions in maintenance costs.

By providing products suited to these processes, NTN is contributing to the production of high-quality cement.

Typical examples of the cement manufacturing process

Raw Materials

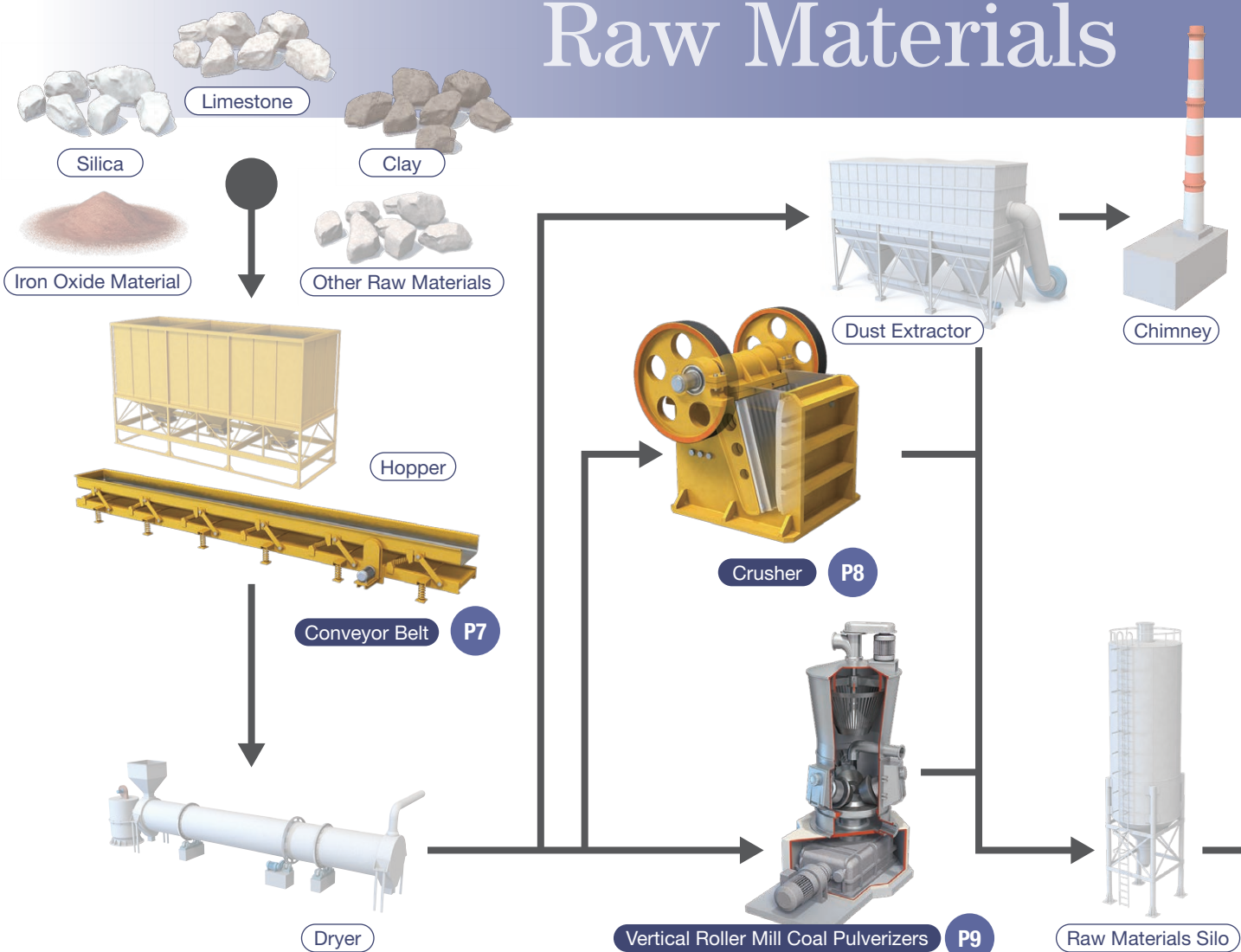

ULTAGE Series
Spherical Roller Bearings
[Type EA, Type EM]

P15



ULTAGE Series
Spherical Roller Bearings with
High-Strength Cage
[Type EMA]

P19

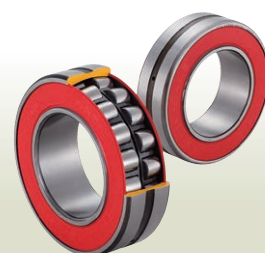

ULTAGE Series
Sealed Spherical Roller Bearings
[Type WA]

P21

Cement Equipment Products

INDEX

	Ref. Page
Conveyor Belts / Bucket Elevators	P7
Crushers	P8
Vertical Roller Mill Coal Pulverizers	P9
Rotary Kilns	P10
Vibrating Screens	P11
Ball Mills	P12
ULTAGE Series Spherical Roller Bearings [Type EA, Type EM]	P15~18
ULTAGE Series Spherical Roller Bearings with High-Strength Cage [Type EMA]	P19~20
ULTAGE Series Sealed Spherical Roller Bearing [Type WA]	P21~22
Bearing Units, Triple-Sealed Bearings for Bearing Units, Plummer Blocks	P23~24
Constant Velocity Joints	P25~26
Dimension Tables	P29~44

Related Catalogs

	Cat. No.
Ball and Roller Bearings	2202/E
Large Bearings	2250/E
ULTAGE Series Spherical Roller Bearings [Type EA, Type EM]	3033/E
ULTAGE Series Spherical Roller Bearings with High-Strength Cage [Type EMA]	3036/E
ULTAGE Series Sealed Spherical Roller Bearings [Type WA]	3703/E
Bearing Units	2400/E
Triple-Sealed Bearings for Bearing Units	3905/E
Plummer Blocks	2500/E
Constant Velocity Joints for Industrial Machines	5603/E
Care and Maintenance of Bearings	3017/E

Firing

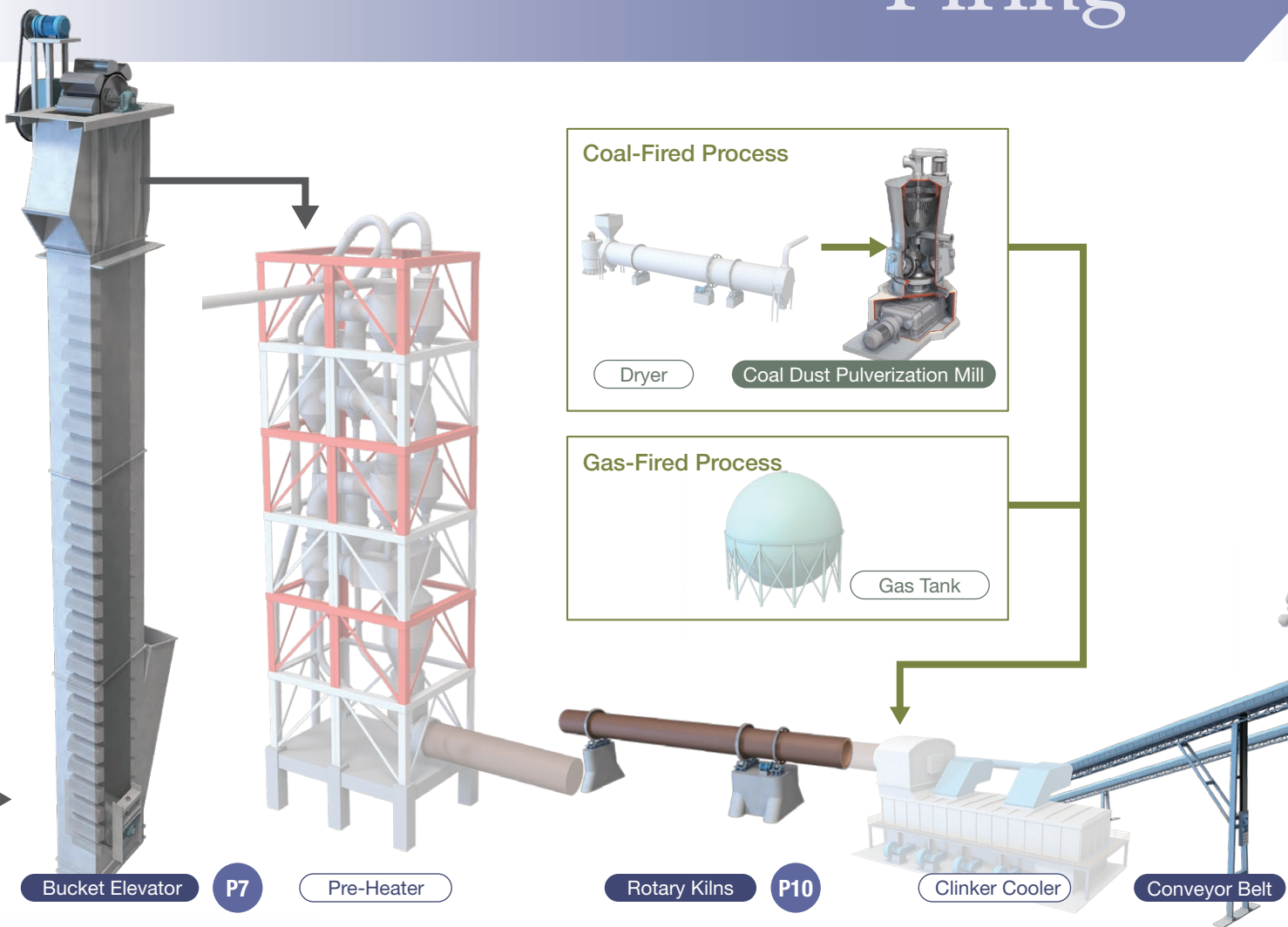

Bearing Units with Covers P23



Bearing Units P23



Triple-Sealed Bearings for Bearing Units P23

Finishing

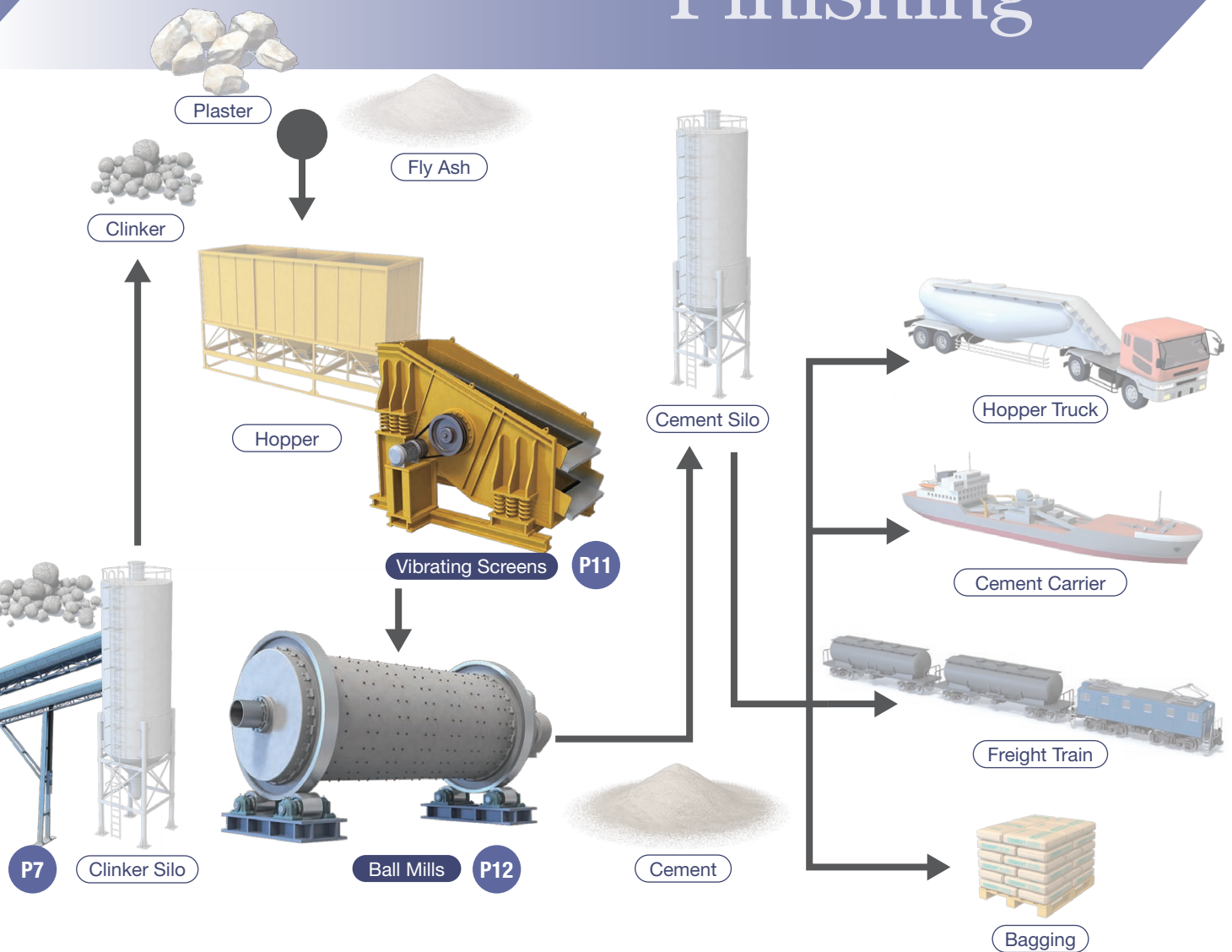

Plummer Blocks P24



Constant Velocity Joints P25



Typical applications where **NTN** products are utilized

P7 ▶ Conveyor Belts / Bucket Elevators

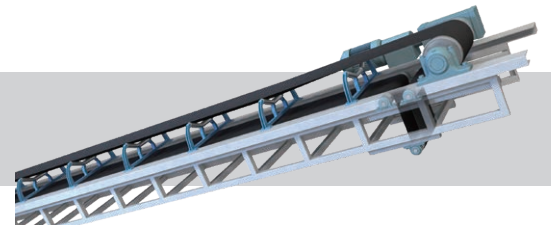

P8 ▶ Crushers

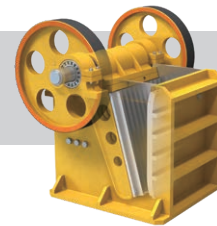

P9 ▶ Vertical Roller Mill Coal Pulverizers

P10 ▶ Rotary Kilns



P11 ▶ Vibrating Screens



P12 ▶ Ball Mills

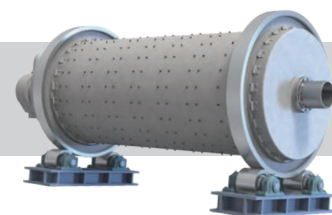

Conveyor Belts / Bucket Elevators

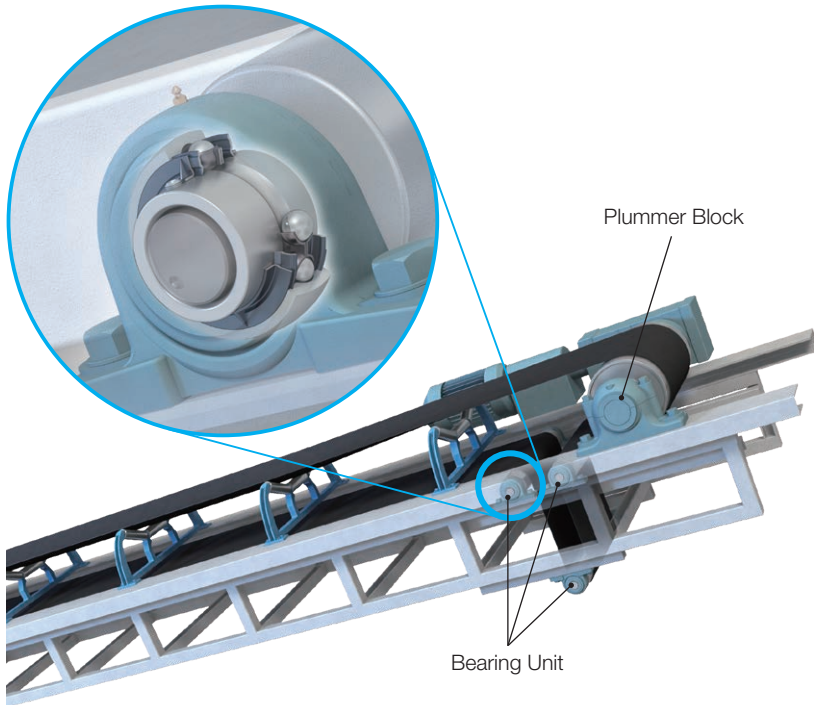

Conveyor Belt

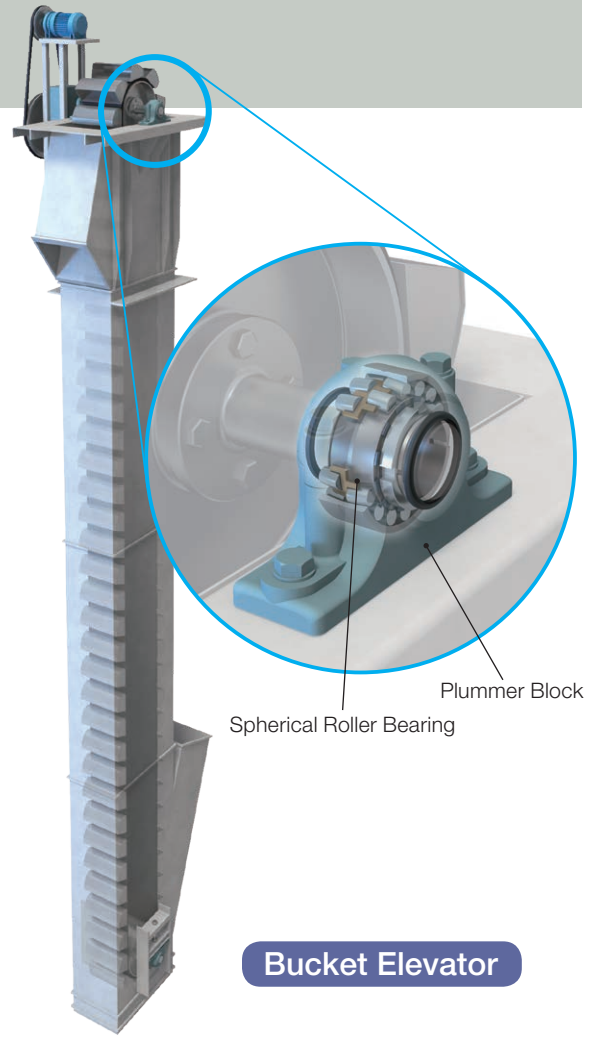

Bucket Elevator

POINT Dust protection with covers or seals

Spherical Roller Bearings (Open Type, Sealed Type) Details shown on P15~22



Plummer Blocks

Details shown on P24



Bearing Units with Covers

Details shown on P23



Triple-Sealed Bearings for Bearing Units

Details shown on P23



Crushers

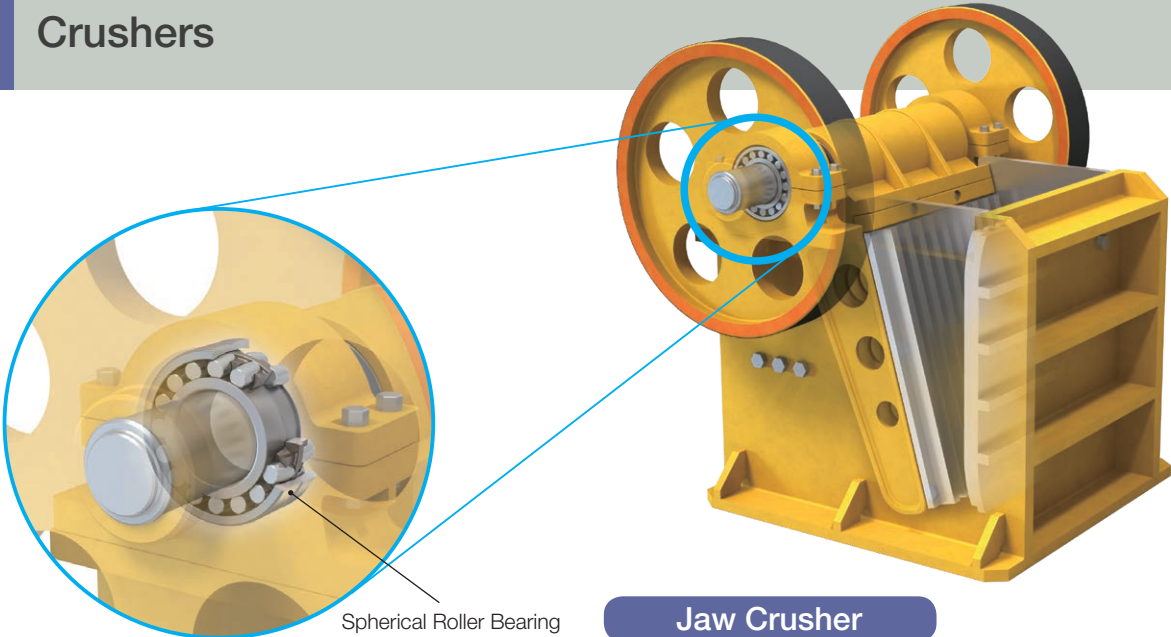

Other Examples

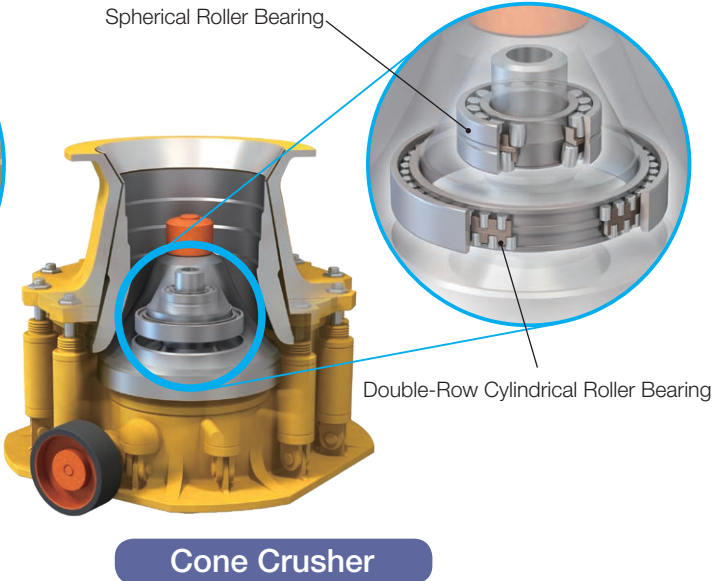
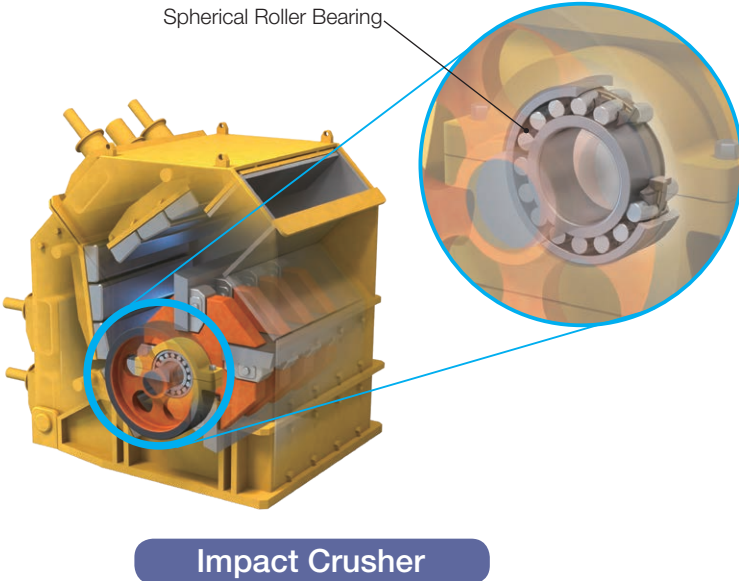

POINT Enhanced vibration resistance

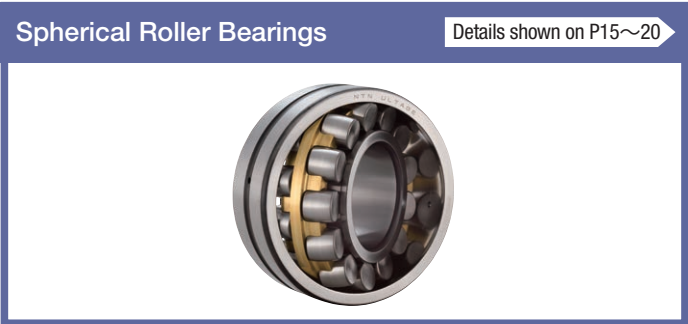

Vertical Roller Mill Coal Pulverizers

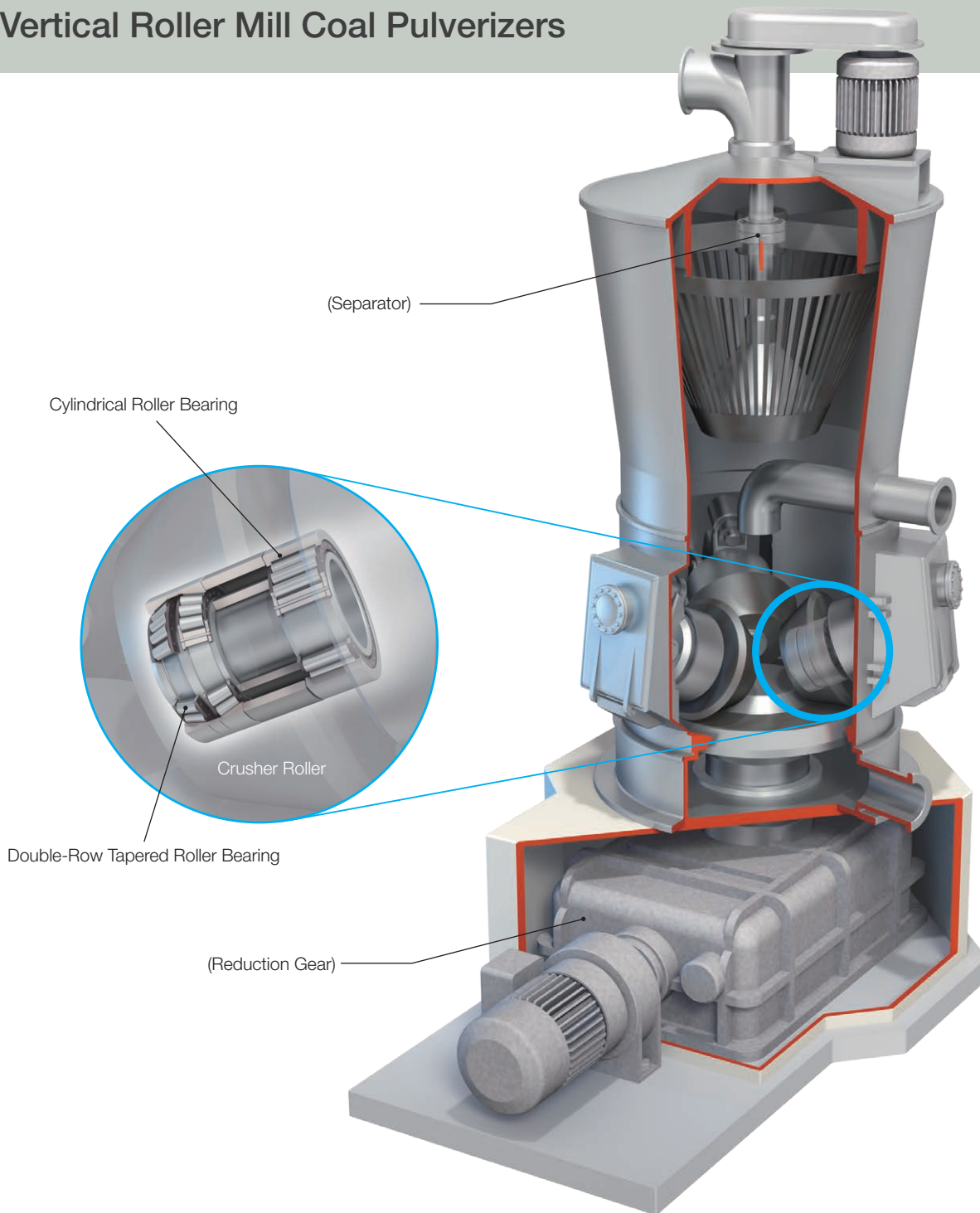

Typical design of vertical roller mill coal pulverizer

Units: mm

Bearing Position		Representative Example 1	Representative Example 2	Representative Example 3
Crusher Roller	Fixed Side	Double-Row Tapered Roller Bearings ($\phi 320 \times \phi 620 \times 280$)	Combined Tapered Roller Bearings ($\phi 480 \times \phi 950 \times 440$)	Combined Tapered Roller Bearings ($\phi 560 \times \phi 1080 \times 470$)
	Floating Side	Cylindrical Roller Bearings ($\phi 320 \times \phi 620 \times 224$)	Cylindrical Roller Bearings ($\phi 500 \times \phi 900 \times 210$)	Cylindrical Roller Bearings ($\phi 580 \times \phi 1000 \times 350$)

Rotary Kilns

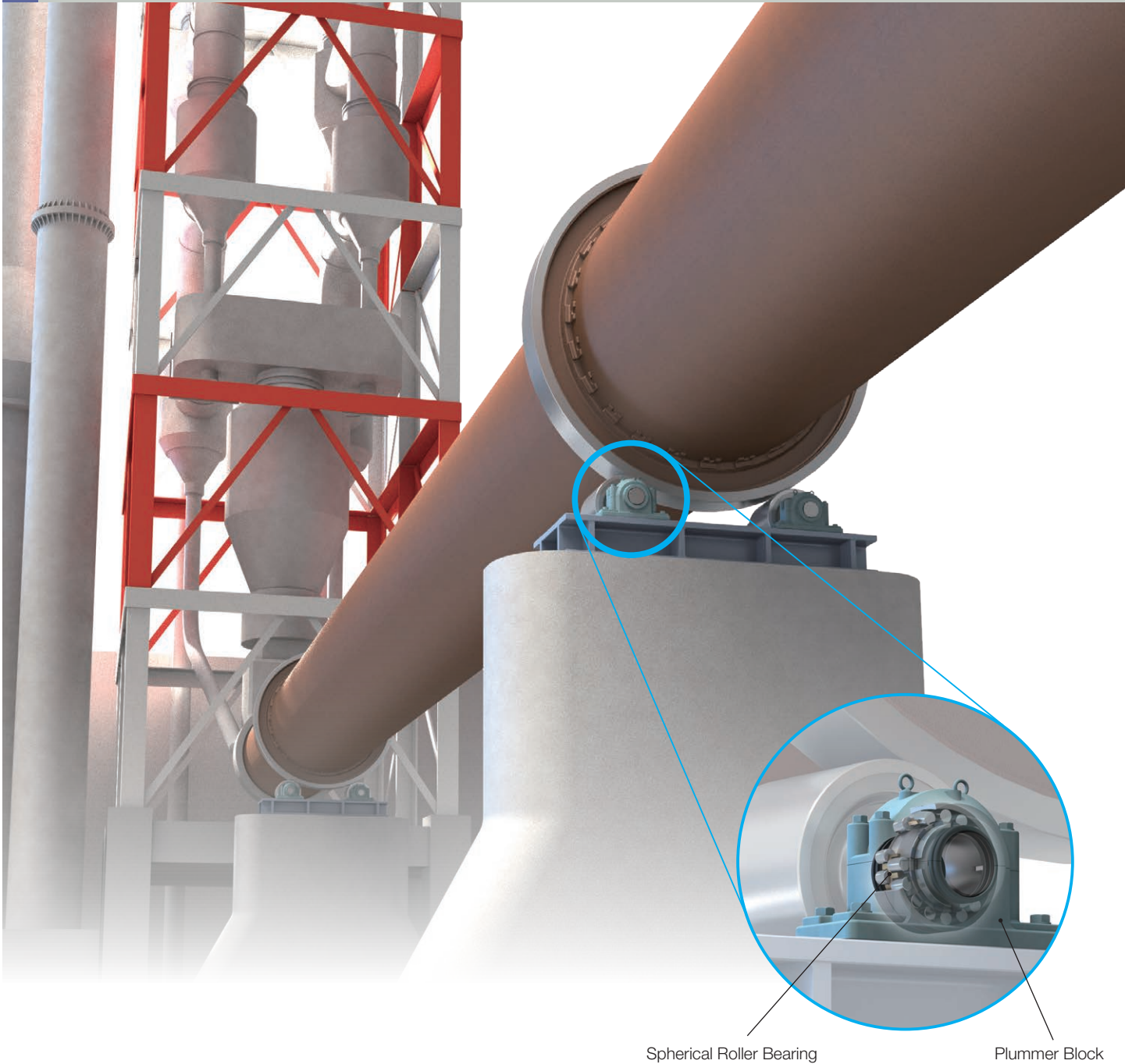

Spherical Roller Bearing

Plummer Block

POINT Heat-resistant specifications to handle high temperatures

Spherical Roller Bearings Details shown on P15~18

Plummer Blocks Details shown on P24

Vibrating Screens

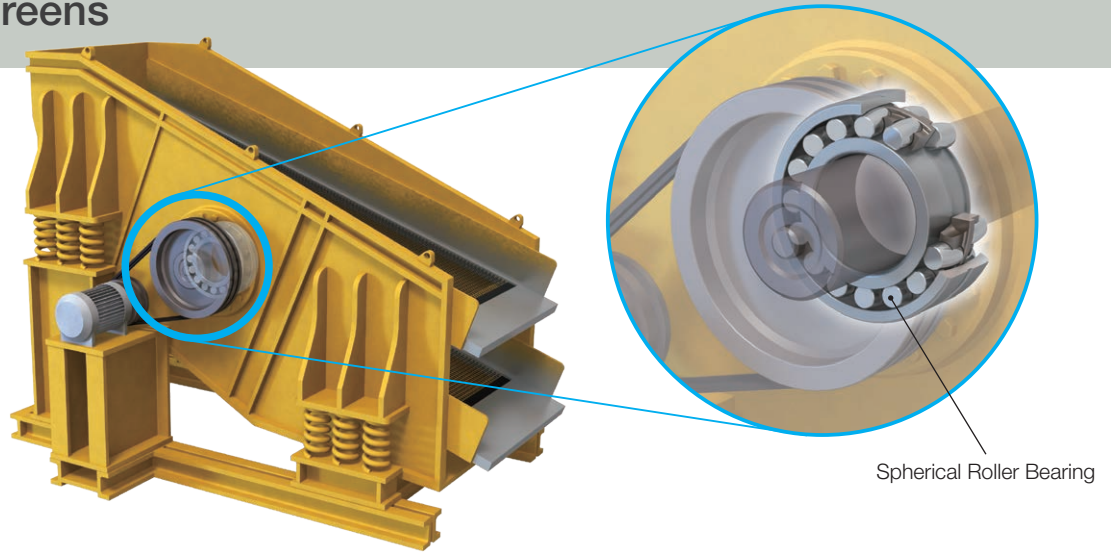

POINT Designed with shaker screen specifications

Spherical Roller Bearings

Details shown on P15~20

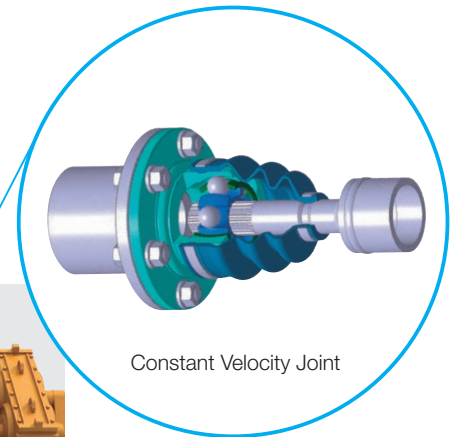
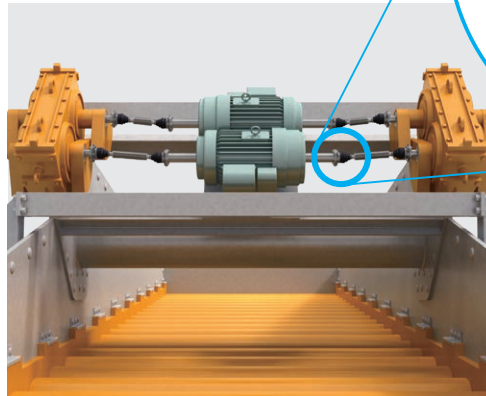

POINT Sealed with boots to provide long operating times without lubrication

Constant Velocity Joints

Details shown on P25~26



Ball Mills

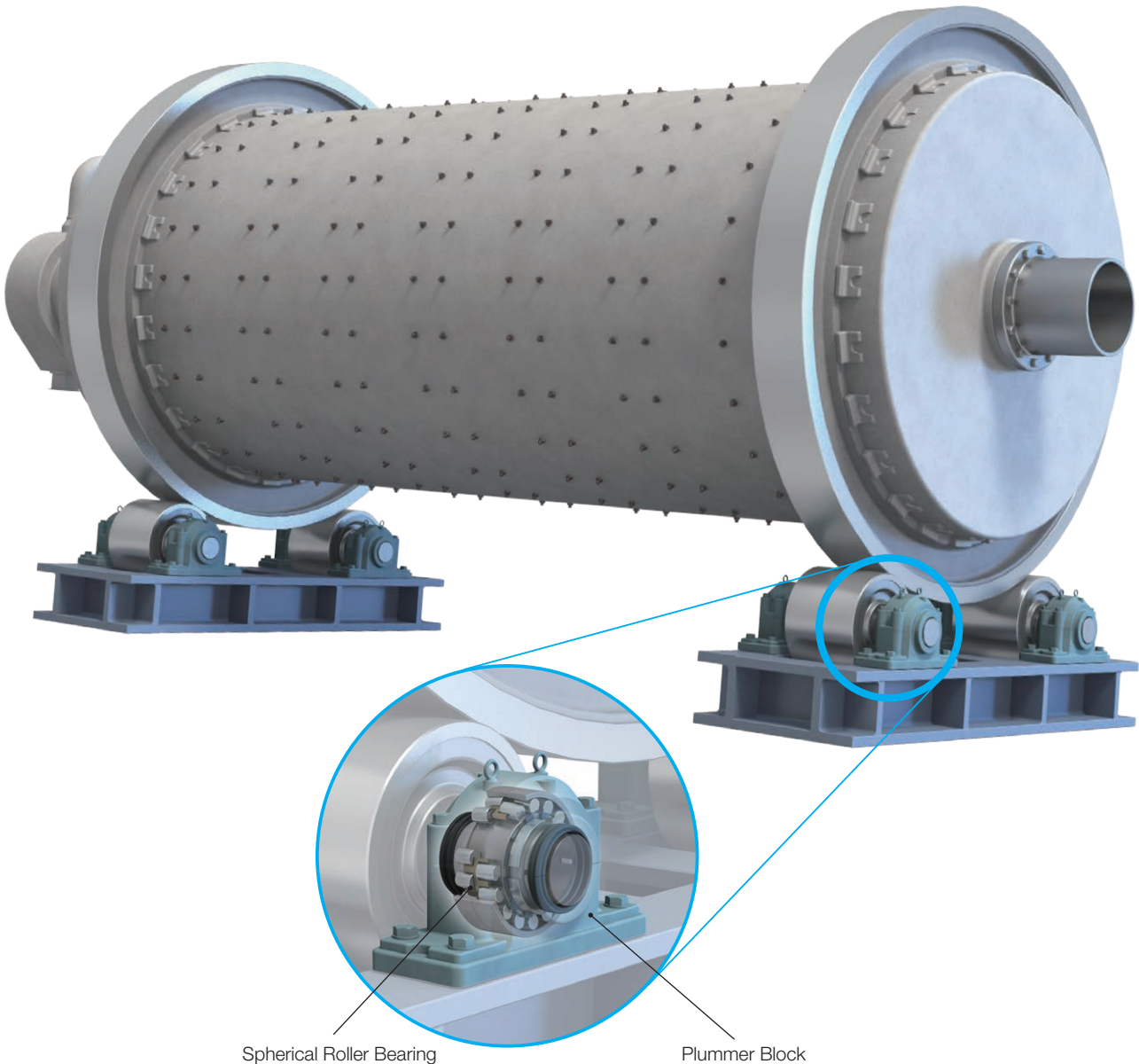

POINT Able to handle high loads

Spherical Roller Bearings Details shown on P15~18

Plummer Blocks Details shown on P24



Details of Cement Equipment Products

P15~18 ▶ ULTAGE Series
Spherical Roller Bearings [Type EA, Type EM]



P19~20 ▶ ULTAGE Series
Spherical Roller Bearings with High-Strength Cage [Type EMA]



P21~22 ▶ ULTAGE Series
Sealed Spherical Roller Bearings [Type WA]

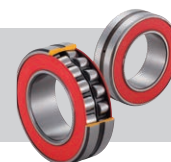

P23 ▶ Bearing Units
Triple-Sealed Bearings for Bearing Units



P24 ▶ Plummer Blocks



P25~26 ▶ Constant Velocity Joints



ULTAGETM ULTAGE Series Spherical Roller Bearings

Long life and higher speed operation

► Type EA, Type EM

Life

Up to **5** times longer

(compared to NTN conventional products)

Limiting Speed

Up to **20** % higher

(compared to NTN conventional products)

Designed for long life and higher speed operation.

Features [Type EA]

Outer Ring

- With lubrication groove and holes
- Optimal curvature

Rollers

- Large rollers
- Maximum number of rollers

Inner Ring

- No rib required
- Optimal curvature

Cage

- Window-type pressed steel cage
- Cage end faces function as guides

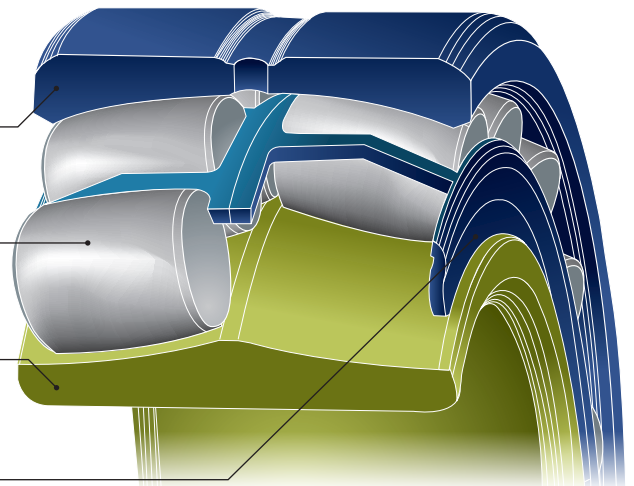

Long Life

- Larger rollers provide the industry's highest load capacity
- Extended maintenance intervals
- Withstands operating temperatures up to 200 °C

Higher Rotational Speed

- The industry's highest allowable rotational speed
- Simple window-type configuration employs a pressed steel cage
- The back face of the cage provides roller guidance and eliminates the need for a guide ring

Easier Handling

- Unique structure readily accepts lubricant
- Easy application of grease

"ULTAGE," a name created from the combination of "Ultimate," signifying refinement, and "Stage," signifying NTN's intention that this series of products be employed in diverse applications, and is the general name for NTN's new generation of bearings that are noted for their industry-leading performance.



● Type EA

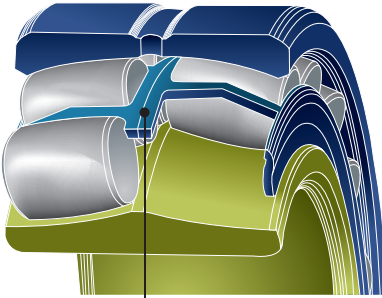

Window-Type Pressed Steel Cage

● Type EM

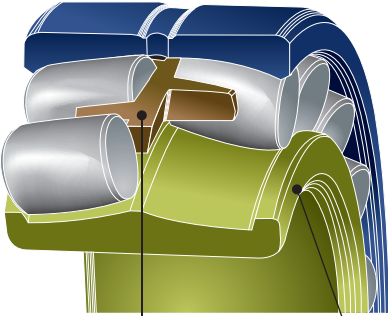

One-Piece Machined Cage Inner Ring Rib

● Type EM (Large Size)

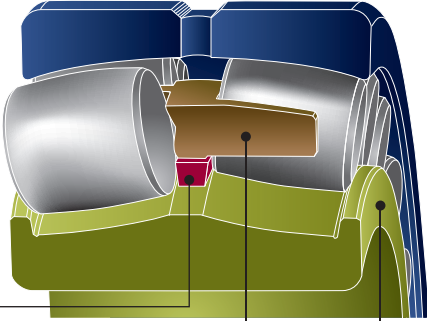

Guide Ring One-Piece Machined Cage Inner Ring Rib

For applications that expose bearings to severe vibration and impact, we recommend Type EM bearings, which incorporate a high-tension brass cage machined from a single piece. (Type EM differs from Type EA in the shape of the inner ring.)

Comparison of Roller Diameter

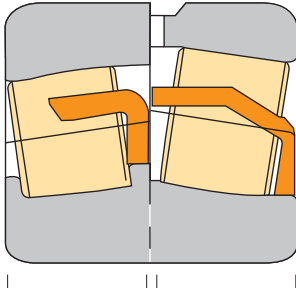

NTN conventional product Type EA

Lubrication Path

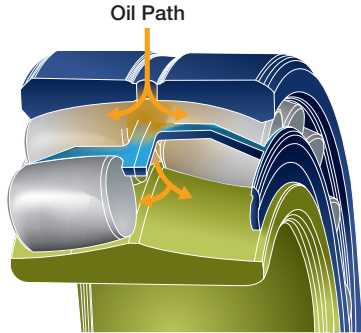

Details of Window-Type Pressed Steel Cage Pockets

Four cage pocket tabs stabilize the roller position.

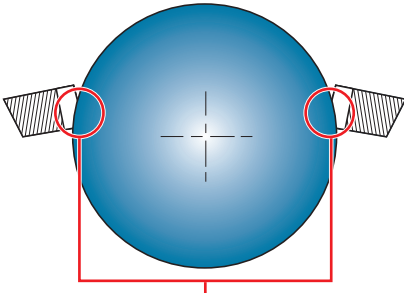
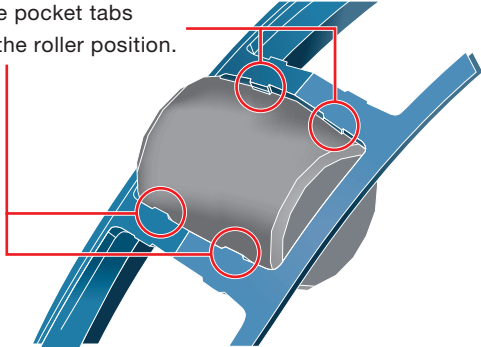

Chamfered cage pocket tabs

- [Allowable Misalignment]
- $0.05 C_r < \text{Dynamic Equivalent Radial Load}$: 0.009 rad (0.5°)
 - $\text{Dynamic Equivalent Radial Load} \leq 0.05 C_r$: 0.035 rad (2°)

* If the installed misalignment is greater than recommended, there is a risk of roller/cage protrusion and impact to surrounding components.

Dimension table on P29

▶ Type EA, Type EM

The Industry's Highest Load Capacity

A significant increase in roller diameter and the use of the maximum number of rollers achieves both a high load capacity and a long service life.

- 1) **Basic Dynamic Load Rating: Up to 65% greater**
(compared to **NTN** conventional products)
- 2) **Basic Static Load Rating: Up to 35% greater**
(compared to **NTN** conventional products)
- 3) **Life: Up to 5 times longer**
(compared to **NTN** conventional products)

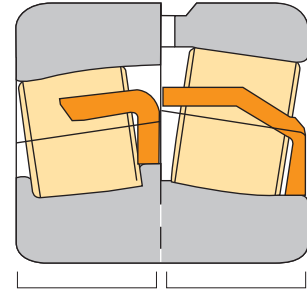

NTN conventional product **Type EA**

- Comparison of basic dynamic load rating (C_r) catalog values with other company products
22216 (ø80 × ø140 × 33)

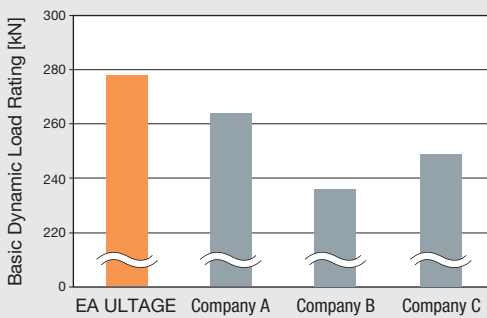

- Comparison of basic static load rating (C_{or}) catalog values with other company products
22216 (ø80 × ø140 × 33)

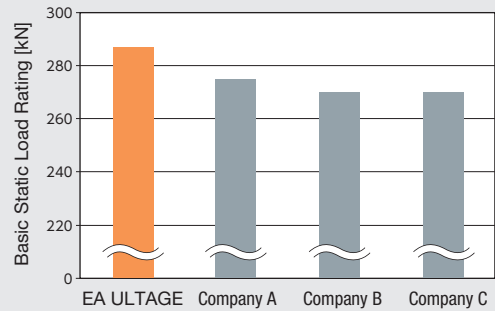

The Industry's Highest Limiting Speed

Use of a window-type configuration with pressed steel cage to achieve higher speed.

Limiting Speed: Up to 20% higher (compared to NTN conventional products)

NTN ULTAGE bearings have industry-leading speed capability and performed with the lowest operational temperature rise compared to other manufacturers during testing.

- Comparison of permitted rotational speed catalog values with other company products
22216 (ø80 × ø140 × 33)

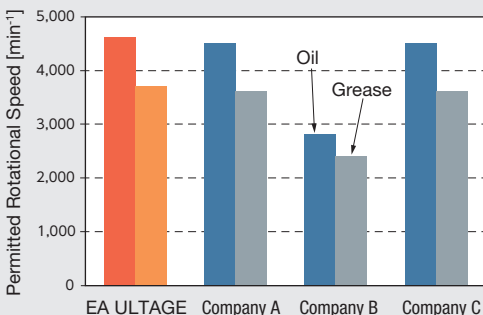

- Temperature rise test results (circulating lubrication)
22216 (ø80 × ø140 × 33)

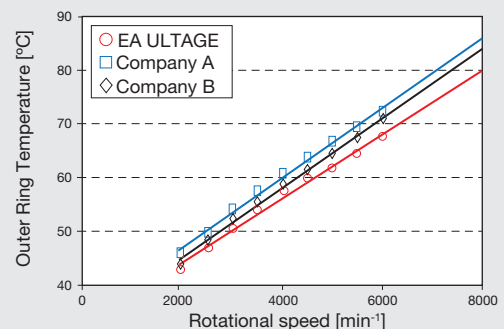



Lighter and More Compact Design

The increased load capacity allows the selection of a smaller sized bearing with similar capacity to that of the conventional design. Allowing for a reduction in size and weight, while maintaining the same theoretical calculated life.

Model Number	Basic Dynamic Load Rating	Basic Static Load Rating	Boundary Dimensions	Mass	Life Ratio
22220B	315	415	ø100×ø180×46	4.95	1
22217EA	324	330	ø85×ø150×36	2.59	1.1
			△ 20%	△ 48%	10%

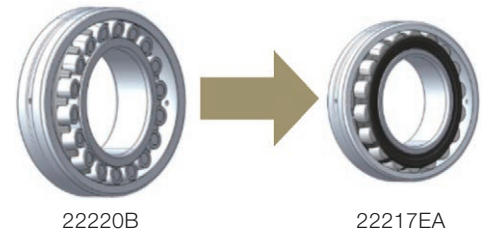

Approx. 20%
reduction in exterior dimensions

48%
reduction in mass ratio

10%
longer calculated life

Outer Ring Lubrication Groove and Holes Equipped as Standard

ULTAGE series equipped with lubrication groove and holes as standard specification. D1 is Japan specification, W33 is Europe specification. (22205, 22206, and 22207 support W33 specification)

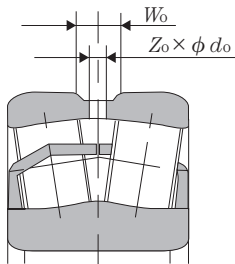

Nominal Outside Diameter mm		Number of Lubrication Holes	
		D1	W33
Min	Less than	Zo	Zo
—	320	4	3
320	600	8	3



Shape of outer ring outside diameter

W_0 and d_o differ according to the model number. Refer to the catalog bearing dimension table.

Do not use lubrication holes for positioning pins.

Easier Handling

Use of a simple window-type configuration with pressed steel cage makes assembly/disassembly work and grease application easier.



Rollers cannot come loose from the cage and return smoothly to their original position, making bearing assembly/disassembly easier.



Easier application of grease to the roller surface.

ULTAGE Series High-Strength Cage Spherical Roller Bearings

Outstanding vibration resistance and impact load performance contributing to an eco-friendly society

▶ Type EMA

Life

Up to **2** times longer

(compared to NTN conventional products)

Cage Strength

Up to **55** % stronger

(compared to NTN conventional products)

Features

● High-Load Capacity Design

Maximizing the diameter and the number of rollers achieves a high-load capacity and longer service life.

Basic Dynamic Load Rating: **Up to 20% greater**
(compared to NTN conventional products)

Life: **Up to 2 times longer**
(compared to NTN conventional products)

● High Strength Cage

Cage strength has been increased by revising the cage shape and incorporating staggered pockets.

Cage Strength: **Up to 55% higher**
(compared to NTN conventional products)

● Low Heat Generation

Lower bearing temperature rise under vibration and impact load conditions.

Bearing Temperature rise: **Up to 10% lower**
(compared to NTN conventional products)

● Heat Resistant Up to 200 °C

Special heat treatment used as standard provides excellent dimensional stability at high temperatures, contributing to a long service life.

* NTN conventional product: Type UA

- Cage**
 - One-piece machined cage with staggered pockets
 - Outer ring guide
- Outer Ring**
 - With lubrication groove and holes
 - Optimal curvature
- Rollers**
 - Large rollers
 - Maximum number of rollers
- Inner Ring**
 - No rib required
 - Optimal curvature

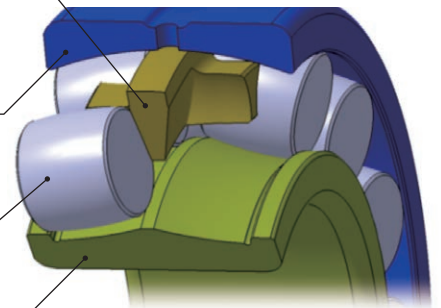

Pockets arranged in the same radial plane Asymmetric rollers

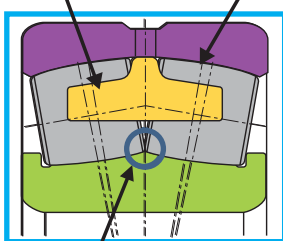

Roller contact design

NTN conventional product

Staggered pockets Symmetric rollers

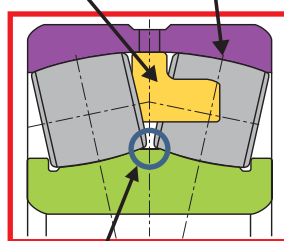

Non-contact design

Type EMA

Sectional views of bearings



NTN conventional product



Type EMA

3D view of cages

Direct interchange from Type UA to Type EMA

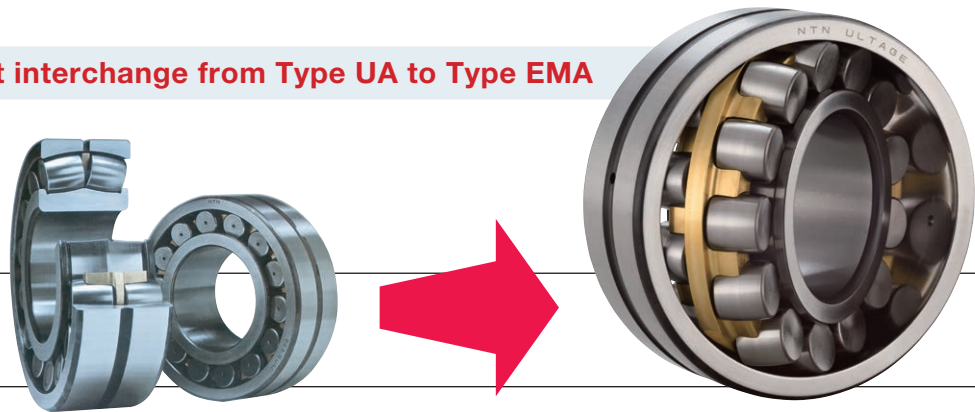

Conventional Type UA

ULTAGE Series Type EMA

Heat Generation Test Results Under Harsh Vibrations

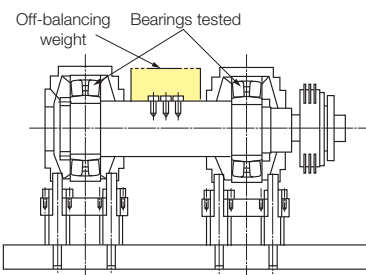
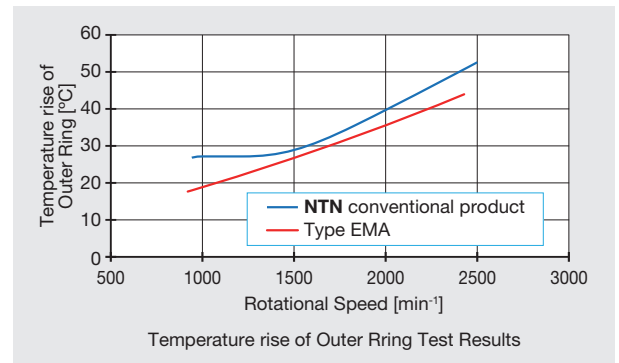

Fig.1 Structure of testing machine

Test Conditions	
Bearing number	22316
Vibration acceleration	Max. 10 G
Rotational speed	800 ~ 2400 min ⁻¹
Lubrication	Oil lubrication (VG150)
Testing machine	Please see Fig. 1



Cage Strength Analysis Results

[Analysis Conditions]

Bearing number: 22316
Vibration acceleration: 100 G

* This cage strength analysis is a comparison of stresses generated in the cage when vibrational acceleration of 100 G is applied to the bearing as an impact load.

Bearing	NTN conventional product	Type EMA
Analysis Data		
Cage Strength	1	1.55

* The cage strength value is obtained by assigning a nominal value of 1 to NTN conventional products.

Allowable Misalignment

- 0.06 Cr < Dynamic Equivalent Radial Load: 0.009 rad (0.5°)
- Dynamic Equivalent Radial Load ≤ 0.06 Cr : 0.035 rad (2°)

* If the installed misalignment is greater than recommended, there is a risk of roller/cage protrusion and impact to surrounding components.

ULTAGE Series Sealed Spherical Roller Bearings

Long life and higher speed operation

▶ Type WA

Life
Up to **5** times longer
(compared to NTN conventional products)

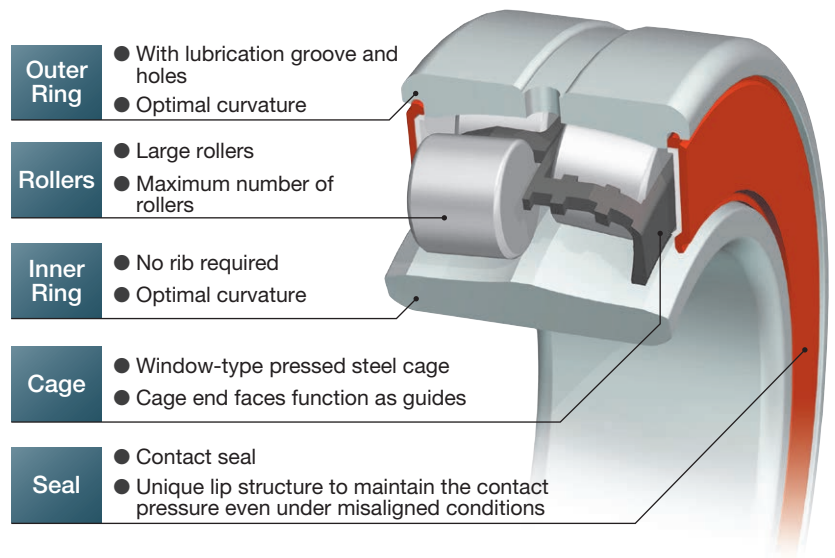
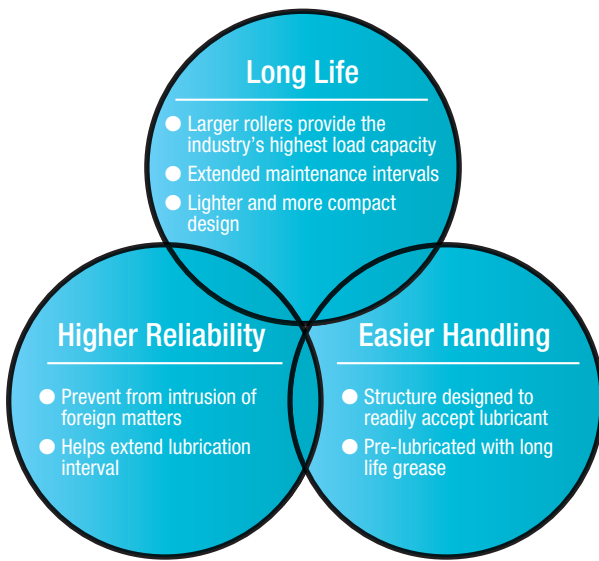

Features

● The Industry's Highest Load Capacity

Both a high load capacity and a longer service life are achieved by adopting the internal design of Type EA spherical roller bearing which has a significantly increased roller diameter and the maximum number of rollers guided with the window-type pressed steel cage.

● Compact Design with Minimized Volume of Seals

Adapted contact type seals with reduced width to allow for larger rollers.

- 1) Prevent the intrusion of foreign matters with uniquely designed contact type rubber seals.
- 2) Secure, dust-proof capability by maintaining the constant contact pressure of seals even under misaligned conditions.

● Prelubricated with a Long Life Grease as Standard

Bearings are prelubricated with a long life grease. No cleaning nor greasing are required when being mounted.

● Lubrication Groove and Holes are Adopted as Standard

Adequate greasing into the bearing is achieved with a lubrication groove and holes on the outside diameter of the outer ring.

● Can be mounted in Standard Plummer Blocks

Although wider than standard spherical roller bearings, they can be mounted in standard type SN5 and SN2 series models.

Note that a standard positioning ring cannot be used when using the bearing on the fixed side. A positioning ring with special width dimensions is required.

Contact **NTN** Engineering for details.

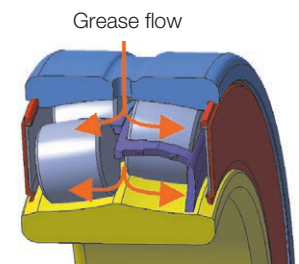
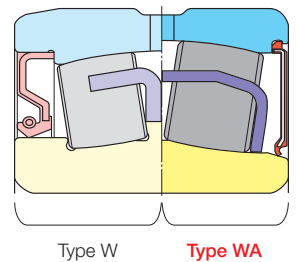

Allowable Misalignment

- 0.009 rad (0.5°)

Allowable Temperature Range

- Bearing temperature: -20 to 110 °C

Permitted Rotational Speed

- When lubricating: $dn \leq 60 \times 10^3$
 - When not lubricating: $dn \leq 80 \times 10^3$
- [$dn = d$ (bearing bore diameter [mm]) \times n (operating rotational speed [min^{-1})]]

Lubricant Grease

- Lubricate with lithium based grease containing extreme pressure additives
- Grease pack amount : 15 to 25% of space capacity

ULTAGE Series Sealed Spherical Roller Bearings [Type WA] are new innovative standard products specifically developed to provide required for all industrial machineries.



Performance Test Results

● Temperature rise Test

[Test Conditions]

- Bearing : WA22218EALLSD1
- Load : radial load 294 N
- Rotational speed : 200 to 1400 min⁻¹
- Lubrication : Lithium based grease containing extreme pressure additives
- Grease pack amount : 20% of space capacity

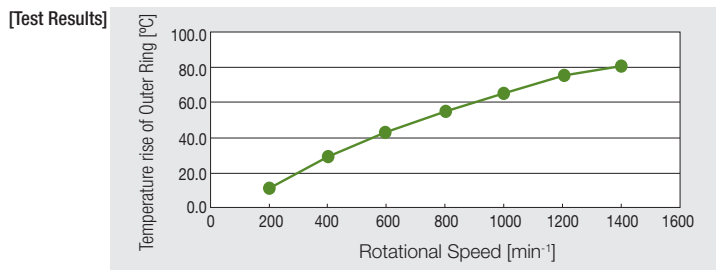

Temperature rise of Outer Ring

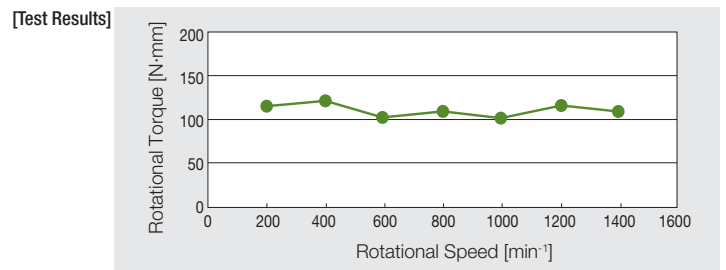

Bearing Rotational Torque

● Noise Test

[Test Conditions]

- Bearing : WA22218EALLSD1
- Load : radial load 980 N
- Rotational speed : 600, 900, 1200 min⁻¹
- Lubrication : Lithium based grease containing extreme pressure additives
- Grease pack amount : 20% of space capacity

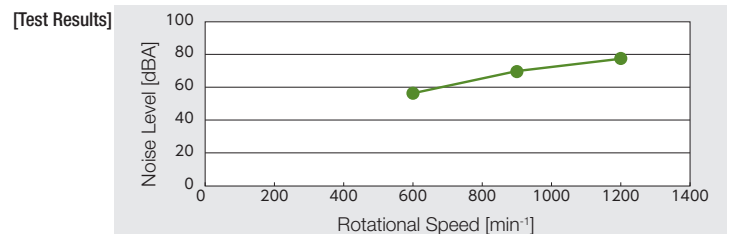

● Grease Leakage Test

[Test Conditions]

- Bearing : WA22218EALLSD1
- Load : radial load 1960 N
- Rotational speed : 1000 min⁻¹
- Lubrication : Lithium based grease containing extreme pressure additives
- Grease pack amount : 20% of space capacity
- Operating time : 100 hours

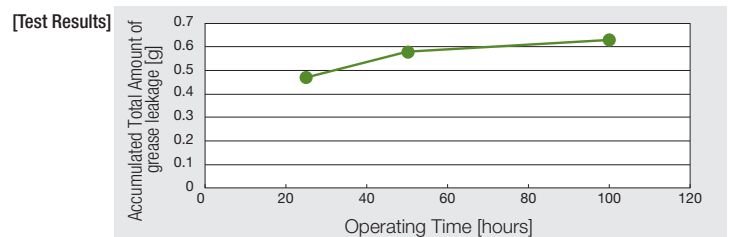

● Dust Test

[Test Conditions]

- Bearing : 22216 (Type WA / open type)
- Load : radial load 196 N
- Rotational speed : 500 min⁻¹
- Lubrication : grease
- Dust : coke dust (20 wt% mixed with housing internal grease)
- Test time : 760 hours (approx. 1 month)

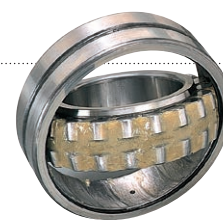
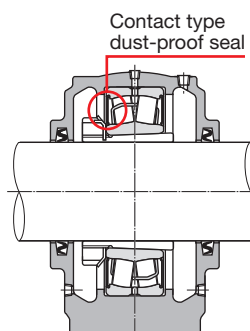

Type WA

No deterioration caused by ingress of coke dust



Open type

Deterioration caused by ingress of coke dust

Dimension table on P41

Bearing Units

- Bearing units provide easy installation and removal with a combination of sealed ball bearings and a wide range of housing designs.
- Self-aligning design for bearing and housing fitting surfaces.
- Selection of maintenance-free types and relubricatable types available to suit the application.

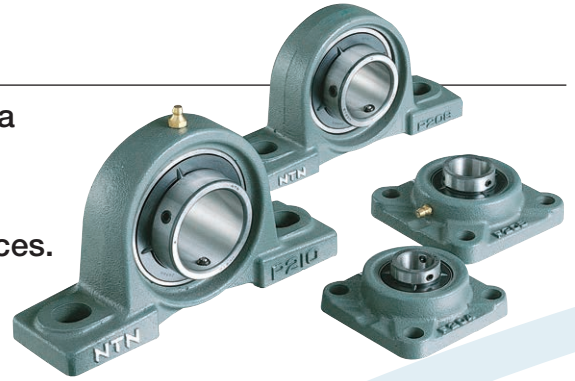

Bearing Units with Covers

- Also available with covers to provide protection from dust.
- Closed cover can be selected for bearing end.
- Cover feature double lipped seals, and an anti-rotating mechanism prevents the seal rotating together with the shaft, for a higher level of sealing.

Cover Seal Structure
 Bearing unit end covers are designed to prevent the seal from rotating with the shaft, which is accomplished through the use of a retaining plate in pressed steel covered versions and through the use of a spring pin in cast iron covered versions.

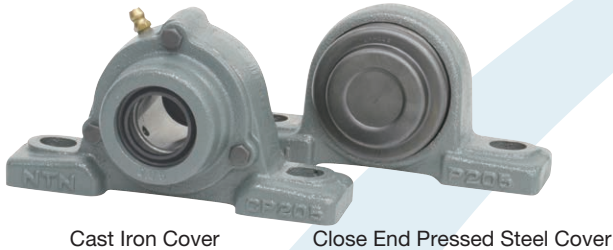

Cast Iron Cover

Close End Pressed Steel Cover

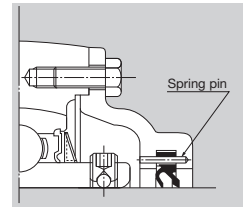

Cast Iron Cover

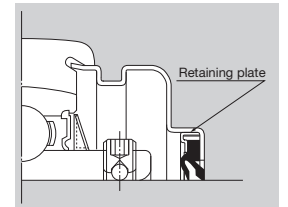

Pressed Steel Cover

Triple-Sealed Bearings for Bearing Units

- The use of a seal with a triple lip structure makes them extremely resistant to dust and water.
- Available as a low-torque type (LLJ) and high-torque type (LLS).

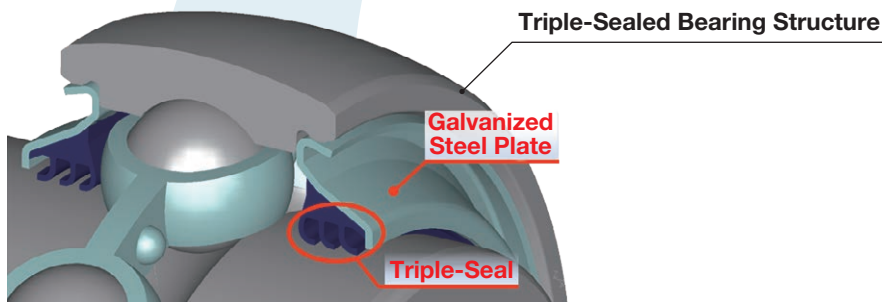

Waterproof Performance Test Results

[Test Conditions]

Bearing	: UC205D1 standard type, LLJ (low-torque type), LLS (high-torque type)
Rotational speed	: 800 min ⁻¹
Load	: no load (belt tension only)
Test mode	: intermittent operation (1 cycle of 6 hours operation / 6 hours stopped)
Test machine	: NTN muddy water test machine
Muddy water specifications:	dust JIS Z 8901 Kanto-loam Class 8 Dust water mixture ratio 1:10 (ratio by weight)
Quantity of muddy water	: dipped to around 1/3 to 1/4 of outer ring
Termination conditions	: Muddy water leakage from bearing, bearing seizure, 0.6 G vibration when operating

[Test Results]

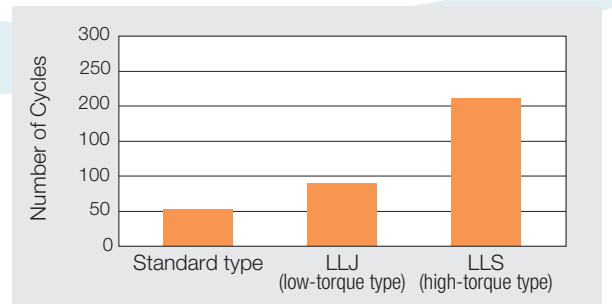

Dimension table on P43

Plummer Blocks

- Impact and vibration resistance (excellent damping capacity), suited to heavy loads.
- Any lubrication method available (grease or oil).



Plummer Block Seal Types

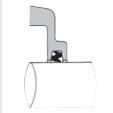

Rubber Seal

Rubber seals are typically used for grease lubrication, and their allowable peripheral speed, as a guideline, ranges from 5 to 6 m/s.



Felt Seal

Felt seals are compatible with rubber seals, but are limited to grease lubrication only. Felt seals are not suitable for dusty or moist environments, and their allowable peripheral speed, as a guideline, is 4 m/s.



S Grease Seal

The S grease seal (synthetic rubber seal with spring) excels in sealing performance and is well suited for grease or oil lubrication (custom specifications can be used with plummer blocks). Recommended peripheral speeds are within a range of 10 to 12 m/s, and special attention is required for the surface roughness and hardness of the shaft in contact with the seal contact area.

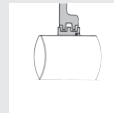

Labyrinth Seal

A sealing type that uses a labyrinth ring. A labyrinth seal is used in clearance fit to a shaft (h9) together with an O-ring so that it can be installed easily and can follow expansion/compression of the shaft.

Specially-Coated Housings are also available



Plummer block usage condition

Constant Velocity Joints

Superior Performance of Constant Velocity Joints

1 Low Vibration/Noise efficient Rotation

CVJs have lower vibrations and noise compared to other joints, and their smooth rotation (constant velocity rotation) helps to improve product quality and stable equipment operation.

2 Easy Handling

CVJs are easier to handle, as they do not require joint angle/positioning or centering between left and right joints like cross joints.

3 No Lubrication Required

Joints are sealed with boots, which means they can be used for extended periods of time without requiring lubrication.

4 Ambient Environment

Joints sealed with boots prevent grease scattering, helping to keep the area they are used in cleaner.

5 Safety

Joints are covered by boots, so users cannot trap their fingers in the joint yoke like cross joints, which enhances safety during handling.

Superiority of Constant Velocity Joints

When non-constant velocity joints such as cross joints (CJ) transmit rotational power from the main shaft to the driven shaft, the angular velocity of the driven shaft changes in two cycles per revolution as shown in Fig. 1, even if the angular velocity of the main shaft is constant. Thus to ensure an almost constant velocity, an intermediate shaft must be used to connect the two joints as a single system, with the two joints arranged at the opposing angles along the same plane or in parallel as shown in Fig. 2.

NTN constant velocity joints are a single unit, so there is no change in angular velocity between the main shaft and driven shaft. This means that even if the center line of both the main and driven shafts varies, they do not need to be arranged on the same plane, and can be set to any desired angle. (Fig. 3)

Fig. 1

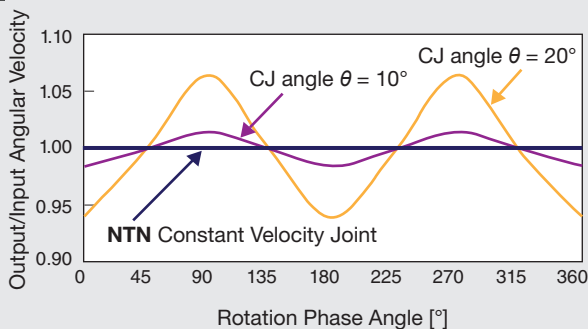
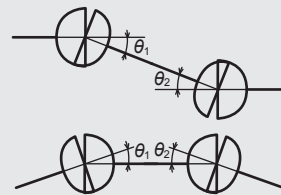

Fig. 2

Cross Joints



By using only a pair of joints $\theta_1 = \theta_2$ is allowed
Phase matching is required

Fig. 3

Constant Velocity Joints

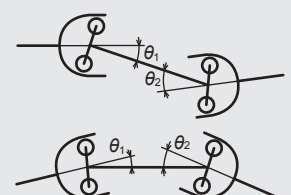

By using only a single joint $\theta_1 \neq \theta_2$ is allowed
Phase matching is not required

Constant Velocity Joints Types

● BJ Disc Type

Excellent high-speed rotation performance.

Maximum Allowable Angle

14 to 18°

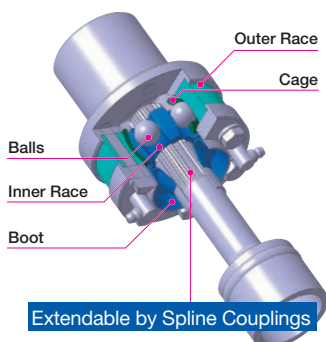

● BJ Cup Type

Excellent seal performance.

Maximum Allowable Angle

25°

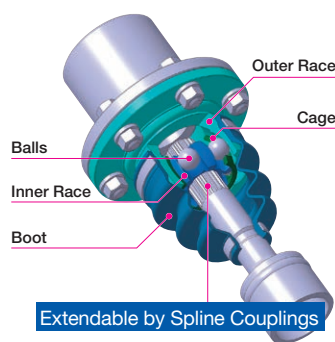

● DOJ

Extendable inside the joint while under torque load.

Maximum Allowable Angle

68 to 200 seizes: 20°
225 to 625 seizes: 8 to 10°

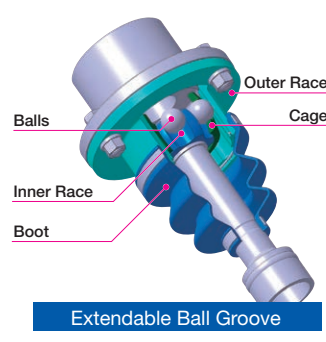

● TBJ TriBall

Compact CVJ that can be expanded internally.

Maximum Allowable Angle

16 to 18°

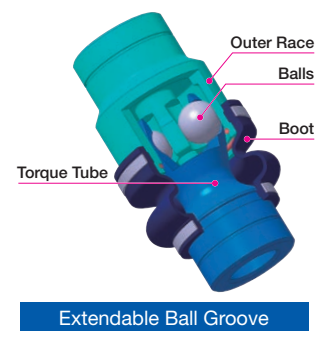

▶ BC Coupling

NTN BC Couplings can be used in the same way as ordinary couplings, making them ideal for replacement.*
 BC Couplings can be easily installed/removed, and provide a large degree angular deflection and eccentricity.

No need to center/easy to install

Maximum Allowable Angle
 5°

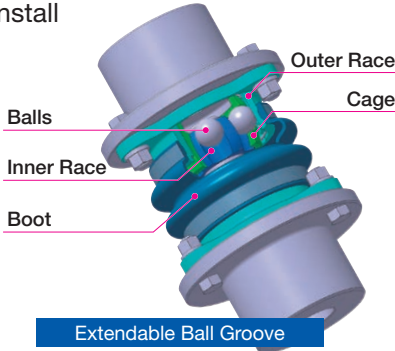

By Substituting with BC Couplings.. **Replacement**

No Centering Required
 Improves work efficiency, reduces maintenance man-hours.

No Lubrication Required
 Boot-sealed to enable operation for prolonged periods without lubricating.

Absorb Vibration

* Replacement may not be possible depending on conditions. Check the conditions and location of use. Contact NTN for technical support.

Comparison of Coupling Types (50 mm bore dia. comparison)

BC Couplings provide greater allowable angular deflection and allowable eccentricity than other types of couplings.

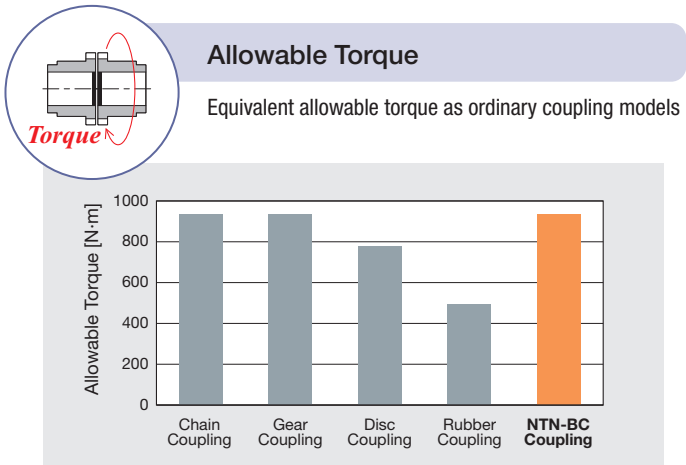
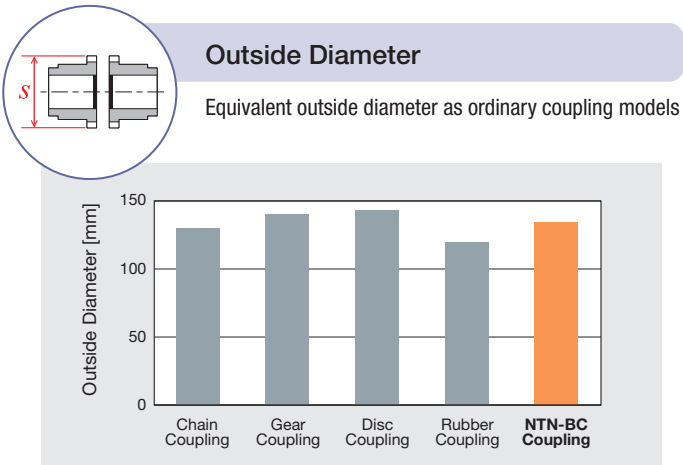
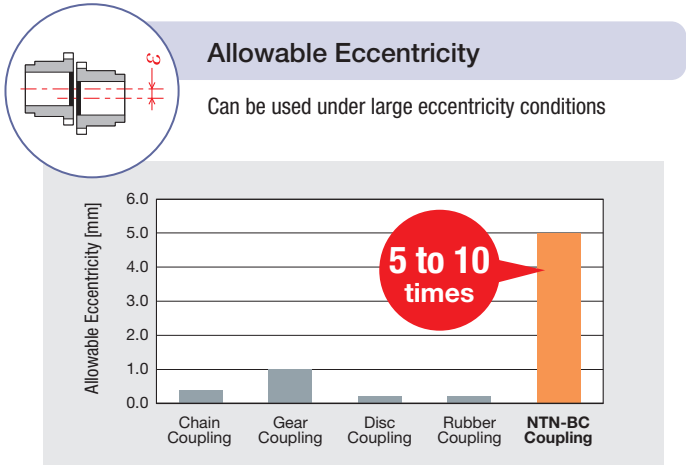
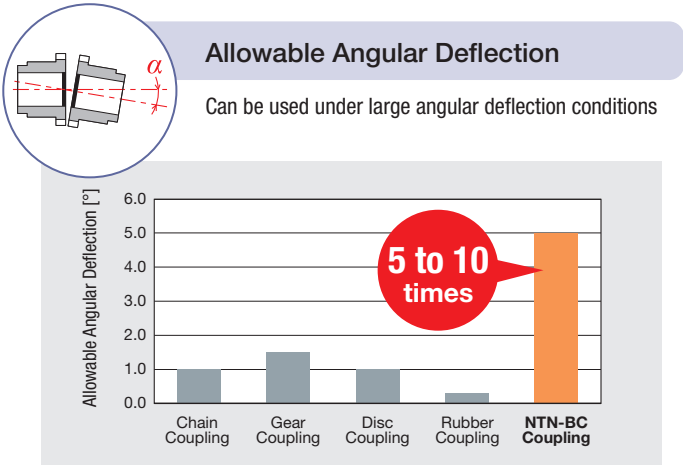

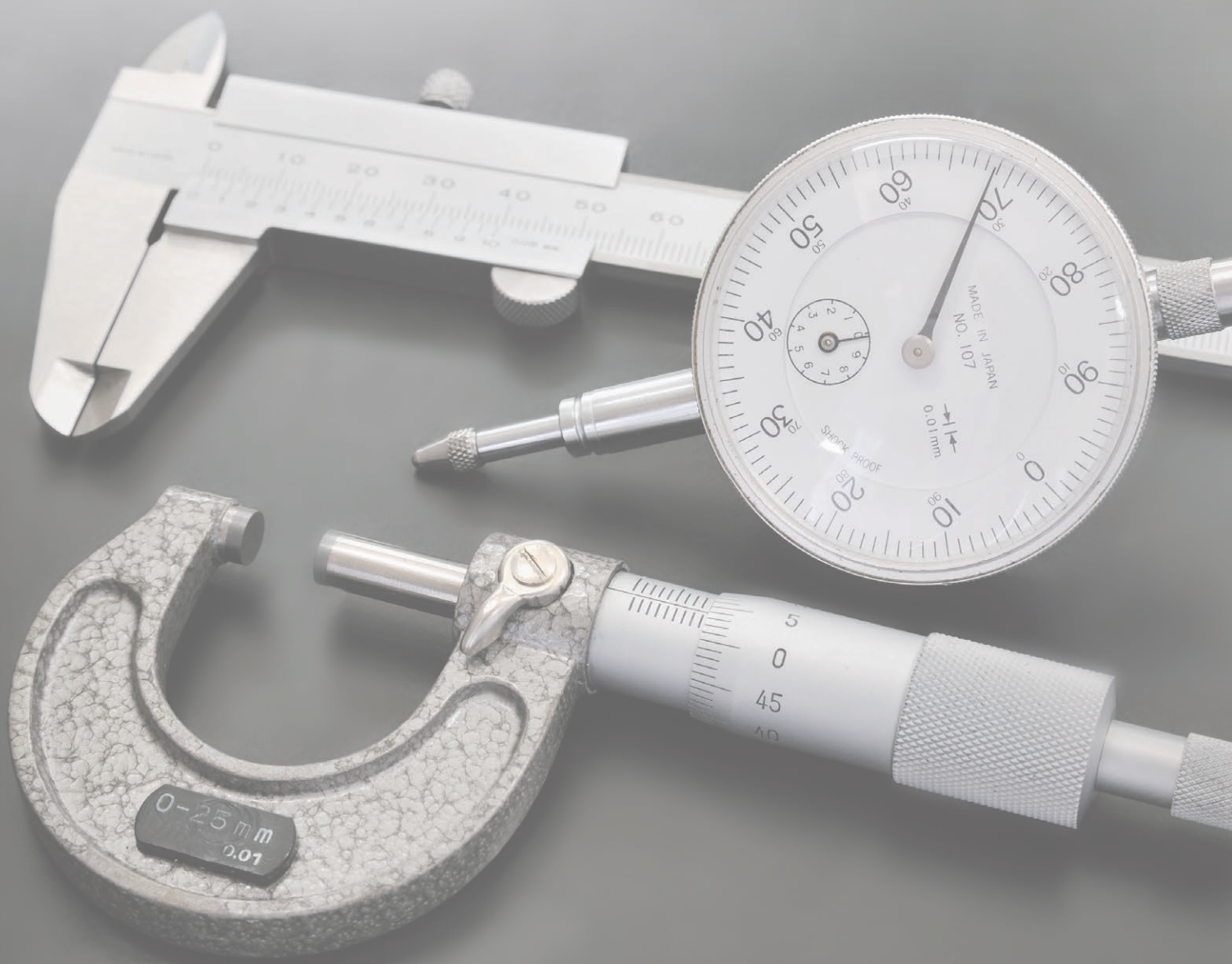

Dimension Tables

P29~38 ▶ ULTAGE Series
Spherical Roller Bearings [Type EA, Type EM]



P39~40 ▶ ULTAGE Series
Spherical Roller Bearings with High-Strength Cage [Type EMA]



P41~42 ▶ ULTAGE Series
Sealed Spherical Roller Bearings [Type WA]

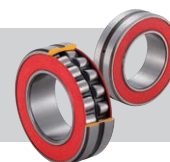

P43~44 ▶ Triple-Sealed Bearings for Bearing Units



ULTAGE Series Spherical Roller Bearings [Type EA, Type EM]

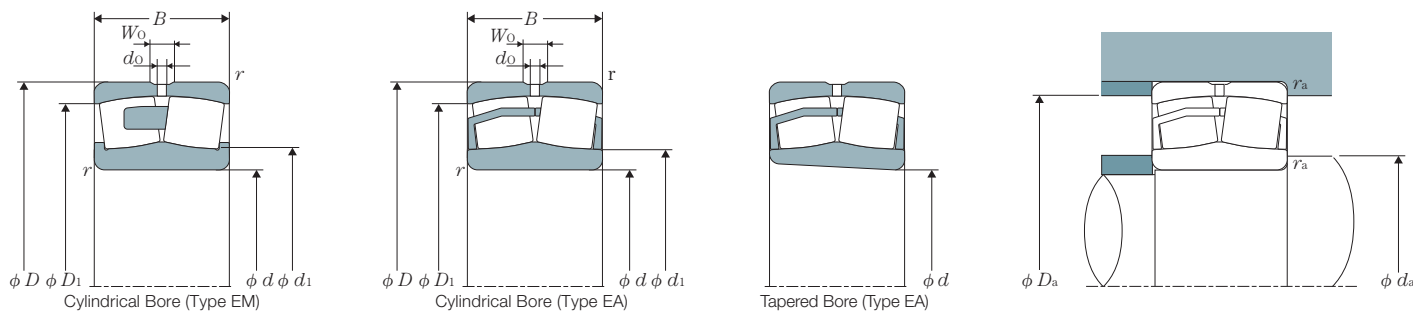

d	Boundary Dimensions					Basic Dynamic Load Rating Cr	Basic Static Load Rating Cor	Basic Dynamic Load Rating Cr	Basic Static Load Rating Cor	Limiting Speeds					
	mm									kN		kgf		min ⁻¹	
	D	B	r _s min ^②	Wo	do					Cr	Cor	Cr	Cor	Grease	Oil
25	52	18	1	3	1.5	57.3	46.1	5 840	4 700	10 400	13 000				
	52	18	1	3	1.5	57.3	46.1	5 840	4 700	10 400	13 000				
30	62	20	1	4	2	75.7	64.5	7 720	6 580	8 800	11 000				
	62	20	1	4	2	75.7	64.5	7 720	6 580	8 800	11 000				
35	72	23	1.1	5	2	100	92	10 200	9 380	7 500	9 400				
	72	23	1.1	5	2	100	92	10 200	9 380	7 500	9 400				
40	80	23	1.1	5	2.5	116	105	11 800	10 700	6 800	8 500				
	80	23	1.1	5	2.5	110	98	11 200	10 000	6 800	8 500				
	90	33	1.5	6	3	169	152	17 200	15 500	5 400	6 600				
	90	33	1.5	6	3	169	152	17 200	15 500	5 400	6 600				
45	85	23	1.1	6	2.5	121	113	12 300	11 500	6 100	7 700				
	85	23	1.1	6	2.5	116	106	11 800	10 800	6 100	7 700				
	100	36	1.5	6	3	206	187	21 000	19 100	4 600	5 700				
	100	36	1.5	6	3	206	187	21 000	19 100	4 600	5 700				
50	90	23	1.1	6	2.5	130	124	13 300	12 600	5 700	7 200				
	90	23	1.1	6	2.5	125	117	12 700	11 900	5 700	7 200				
	110	40	2	7	3.5	250	232	25 400	23 700	4 300	5 300				
	110	40	2	7	3.5	250	232	25 400	23 700	4 300	5 300				
55	100	25	1.5	6	3	155	148	15 800	15 100	5 300	6 700				
	100	25	1.5	6	3	148	140	15 100	14 300	5 300	6 700				
	120	43	2	8	3.5	296	274	30 200	28 000	3 900	4 800				
	120	43	2	8	3.5	296	274	30 200	28 000	3 900	4 800				
60	110	28	1.5	7	3	187	181	19 100	18 400	4 800	6 000				
	110	28	1.5	7	3	179	171	18 300	17 400	4 800	6 000				
	130	46	2.1	9	4	340	319	34 700	32 600	3 600	4 600				
	130	46	2.1	9	4	340	319	34 700	32 600	3 600	4 600				
65	120	31	1.5	8	3.5	226	224	23 100	22 900	4 400	5 500				
	120	31	1.5	8	3.5	217	212	22 100	21 600	4 400	5 500				
	140	48	2.1	9	4	369	343	37 600	35 000	3 300	4 100				
	140	48	2.1	9	4	369	343	37 600	35 000	3 300	4 100				
70	125	31	1.5	7	3.5	235	240	24 000	24 400	4 100	5 200				
	125	31	1.5	7	3.5	235	240	24 000	24 400	4 100	5 200				
	150	51	2.1	10	5	420	396	42 800	40 400	3 000	3 800				
	150	51	2.1	10	5	420	396	42 800	40 400	3 000	3 800				
75	130	31	1.5	7	3.5	244	249	24 800	25 400	4 000	5 000				
	130	31	1.5	7	3.5	244	249	24 800	25 400	4 000	5 000				
	160	55	2.1	10	5	491	467	50 100	47 600	2 900	3 600				
	160	55	2.1	10	5	491	467	50 100	47 600	2 900	3 600				
80	140	33	2	8	3.5	278	287	28 400	29 300	3 700	4 600				
	140	33	2	8	3.5	267	272	27 300	27 700	3 700	4 600				
	170	58	2.1	10	5	541	522	55 200	53 200	2 700	3 400				
	170	58	2.1	10	5	541	522	55 200	53 200	2 700	3 400				
85	150	36	2	8	3.5	324	330	33 000	33 600	3 400	4 300				
	150	36	2	8	3.5	324	330	33 000	33 600	3 400	4 300				
	180	60	3	11	5	599	604	61 100	61 600	2 600	3 200				
	180	60	3	11	5	599	604	61 100	61 600	2 600	3 200				

① "K" indicates bearings have tapered bore with a taper ratio of 1:12. ② Smallest allowable dimension for chamfer dimension r .

Dynamic Equivalent Radial Load

$$P_r = X F_r + Y F_a$$

$\frac{F_a}{F_r} \leq e$		$\frac{F_a}{F_r} > e$	
X	Y	X	Y
1	Y ₁	0.67	Y ₂

Static Equivalent Radial Load

$$P_{0r} = F_r + Y_0 F_a$$

For values *e*, *Y*₁, *Y*₂ and *Y*₀ see the following table.

Bearing Number

222	16	EA	K	D1	C3
-----	----	----	---	----	----

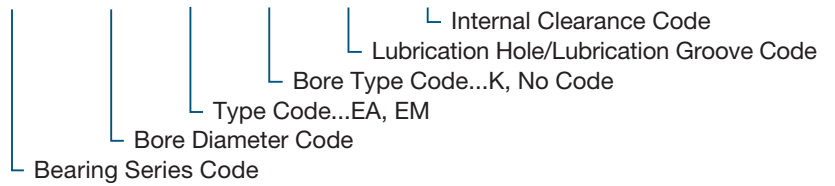

Bearing Numbers		Abutment and Fillet Dimensions					Constant	Axial Load Factors			Mass (approx.)	
Cylindrical Bore	Tapered Bore ^①	<i>d</i> ₁	<i>d</i> _{a min}	<i>D</i> _{a max}	<i>D</i> ₁	<i>r</i> _{as max}	<i>e</i>	<i>Y</i> ₁	<i>Y</i> ₂	<i>Y</i> ₀	Cylindrical Bore	Tapered Bore
22205EAW33	22205EAKW33	30	30	46	46	1	0.34	2.00	2.98	1.96	0.173	0.169
22205EMW33	22205EMKW33	30	30	46	46	1	0.34	2.00	2.98	1.96	0.174	0.171
22206EAW33	22206EAKW33	37	36	56	55	1	0.31	2.15	3.20	2.10	0.278	0.272
22206EMW33	22206EMKW33	37	36	56	55	1	0.31	2.15	3.20	2.10	0.281	0.275
22207EAW33	22207EAKW33	45	42	65	63	1.1	0.31	2.21	3.29	2.16	0.438	0.430
22207EMW33	22207EMKW33	45	42	65	63	1.1	0.31	2.21	3.29	2.16	0.442	0.433
22208EAD1	22208EAKD1	50	47	73	71	1.1	0.27	2.47	3.67	2.41	0.528	0.518
22208EMD1	22208EMKD1	50	47	73	71	1.1	0.27	2.47	3.67	2.41	0.529	0.519
22308EAD1	22308EAKD1	52	49	81	78	1.5	0.36	1.87	2.79	1.83	1.02	1.00
22308EMD1	22308EMKD1	52	49	81	78	1.5	0.36	1.87	2.79	1.83	1.03	1.01
22209EAD1	22209EAKD1	54	52	78	76	1.1	0.26	2.64	3.93	2.58	0.572	0.561
22209EMD1	22209EMKD1	54	52	78	76	1.1	0.26	2.64	3.93	2.58	0.577	0.566
22309EAD1	22309EAKD1	58	54	91	87	1.5	0.36	1.90	2.83	1.86	1.37	1.34
22309EMD1	22309EMKD1	58	54	91	87	1.5	0.36	1.90	2.83	1.86	1.38	1.35
22210EAD1	22210EAKD1	59	57	83	81	1.1	0.24	2.84	4.23	2.78	0.614	0.602
22210EMD1	22210EMKD1	59	57	83	81	1.1	0.24	2.84	4.23	2.78	0.616	0.604
22310EAD1	22310EAKD1	63	61	99	95	2	0.36	1.87	2.79	1.83	1.82	1.79
22310EMD1	22310EMKD1	63	61	99	95	2	0.36	1.87	2.79	1.83	1.84	1.80
22211EAD1	22211EAKD1	66	64	91	90	1.5	0.23	2.95	4.40	2.89	0.830	0.814
22211EMD1	22211EMKD1	66	64	91	90	1.5	0.23	2.95	4.40	2.89	0.827	0.811
22311EAD1	22311EAKD1	68	66	109	104	2	0.36	1.87	2.79	1.83	2.31	2.26
22311EMD1	22311EMKD1	68	66	109	104	2	0.36	1.87	2.79	1.83	2.34	2.29
22212EAD1	22212EAKD1	71	69	101	99	1.5	0.24	2.84	4.23	2.78	1.14	1.12
22212EMD1	22212EMKD1	71	69	101	99	1.5	0.24	2.84	4.23	2.78	1.15	1.13
22312EAD1	22312EAKD1	75	72	118	113	2.1	0.35	1.95	2.90	1.91	2.86	2.80
22312EMD1	22312EMKD1	75	72	118	113	2.1	0.35	1.95	2.90	1.91	2.91	2.85
22213EAD1	22213EAKD1	78	74	111	107	1.5	0.24	2.79	4.15	2.73	1.52	1.49
22213EMD1	22213EMKD1	78	74	111	107	1.5	0.24	2.79	4.15	2.73	1.53	1.50
22313EAD1	22313EAKD1	81	77	128	122	2.1	0.33	2.06	3.06	2.01	3.48	3.41
22313EMD1	22313EMKD1	81	77	128	122	2.1	0.33	2.06	3.06	2.01	3.50	3.43
22214EAD1	22214EAKD1	84	79	116	113	1.5	0.22	3.01	4.48	2.94	1.61	1.58
22214EMD1	22214EMKD1	84	79	116	113	1.5	0.22	3.01	4.48	2.94	1.64	1.60
22314EAD1	22314EAKD1	85	82	138	131	2.1	0.34	2.00	2.98	1.96	4.25	4.16
22314EMD1	22314EMKD1	85	82	138	131	2.1	0.34	2.00	2.98	1.96	4.31	4.22
22215EAD1	22215EAKD1	88	84	121	118	1.5	0.22	3.14	4.67	3.07	1.67	1.64
22215EMD1	22215EMKD1	88	84	121	118	1.5	0.22	3.14	4.67	3.07	1.71	1.67
22315EAD1	22315EAKD1	91	87	148	139	2.1	0.34	2.00	2.98	1.96	5.18	5.07
22315EMD1	22315EMKD1	91	87	148	139	2.1	0.34	2.00	2.98	1.96	5.27	5.16
22216EAD1	22216EAKD1	94	91	129	127	2	0.22	3.14	4.67	3.07	2.09	2.05
22216EMD1	22216EMKD1	94	91	129	127	2	0.22	3.14	4.67	3.07	2.11	2.07
22316EAD1	22316EAKD1	98	92	158	148	2.1	0.34	2.00	2.98	1.96	6.12	5.99
22316EMD1	22316EMKD1	98	92	158	148	2.1	0.34	2.00	2.98	1.96	6.28	6.15
22217EAD1	22217EAKD1	100	96	139	137	2	0.22	3.07	4.57	3.00	2.59	2.54
22217EMD1	22217EMKD1	100	96	139	137	2	0.22	3.07	4.57	3.00	2.67	2.62
22317EAD1	22317EAKD1	107	99	166	157	3	0.32	2.09	3.11	2.04	7.18	7.04
22317EMD1	22317EMKD1	107	99	166	157	3	0.32	2.09	3.11	2.04	7.29	7.15

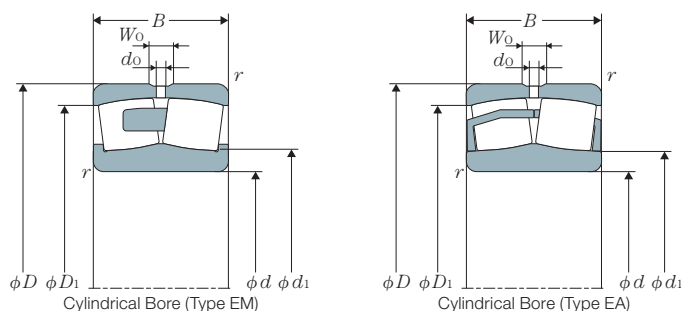

d	Boundary Dimensions					Basic Dynamic Load Rating Cr	Basic Static Load Rating Cor	Basic Dynamic Load Rating Cr	Basic Static Load Rating Cor	Limiting Speeds					
	mm									kN		kgf		min ⁻¹	
	D	B	r _s min ^②	Wo	do					Cr	Cor	Cr	Cor	Grease	Oil
90	160	40	2	10	4.5	384	398	39 200	40 600	3 200	4 000				
	160	40	2	10	4.5	384	398	39 200	40 600	3 200	4 000				
	160	52.4	2	9	4	467	513	47 700	52 300	2 600	3 200				
	190	64	3	12	5	668	652	68 100	66 400	2 500	3 000				
	190	64	3	12	5	668	652	68 100	66 400	2 500	3 000				
95	170	43	2.1	10	4.5	416	417	42 400	42 600	3 000	3 800				
	170	43	2.1	10	4.5	416	417	42 400	42 600	3 000	3 800				
	200	67	3	12	6	732	751	74 600	76 500	2 300	2 800				
	200	67	3	12	6	732	751	74 600	76 500	2 300	2 800				
100	165	52	2	8	4	464	563	47 300	57 400	2 400	3 000				
	165	52	2	8	4	480	590	49 000	60 100	2 400	3 000				
	180	46	2.1	11	5	472	495	48 100	50 500	2 800	3 600				
	180	46	2.1	11	5	472	495	48 100	50 500	2 800	3 600				
	180	60.3	2.1	9	4.5	586	661	59 800	67 400	2 300	2 900				
	215	73	3	13	6	827	844	84 300	86 100	2 100	2 600				
110	215	73	3	13	6	827	844	84 300	86 100	2 100	2 600				
	170	45	2	8	3.5	417	517	42 500	52 700	2 600	3 300				
	170	45	2	8	3.5	417	517	42 500	52 700	2 600	3 300				
	180	56	2	9	4	547	669	55 800	68 200	2 200	2 800				
	180	56	2	9	4	547	669	55 800	68 200	2 200	2 800				
	180	69	2	8	4	622	769	63 400	78 400	2 200	2 700				
	200	53	2.1	12	6	602	643	61 400	65 600	2 600	3 300				
	200	53	2.1	12	6	602	643	61 400	65 600	2 600	3 300				
120	200	69.8	2.1	11	5	752	869	76 700	88 600	2 100	2 600				
	240	80	3	16	7	975	972	99 500	99 100	2 000	2 400				
	240	80	3	16	7	975	972	99 500	99 100	2 000	2 400				
	180	46	2	8	3.5	446	577	45 500	58 900	2 400	3 100				
	180	46	2	8	3.5	446	577	45 500	58 900	2 400	3 100				
	180	60	2	8	3.5	526	726	53 700	74 100	2 100	2 600				
	200	62	2	10	4.5	663	820	67 600	83 600	2 000	2 500				
	200	62	2	10	4.5	663	820	67 600	83 600	2 000	2 500				
	200	80	2	10	4.5	756	991	77 100	101 000	1 900	2 500				
	215	58	2.1	12	6	688	753	70 100	76 800	2 400	3 000				
130	215	58	2.1	12	6	688	753	70 100	76 800	2 400	3 000				
	215	76	2.1	11	5	857	998	87 300	102 000	1 900	2 400				
	260	86	3	18	8	1 170	1 280	119 000	131 000	1 800	2 200				
	260	86	3	18	8	1 170	1 280	119 000	131 000	1 800	2 200				
	200	52	2	9	4	565	721	57 600	73 500	2 200	2 900				
	200	52	2	9	4	565	721	57 600	73 500	2 200	2 900				
	200	69	2	9	4	682	936	69 600	95 400	1 900	2 400				
	210	64	2	10	4.5	710	906	72 400	92 400	1 900	2 400				
	210	64	2	10	4.5	710	906	72 400	92 400	1 900	2 400				
	210	80	2	10	4.5	803	1 080	81 900	110 000	1 800	2 400				
	230	64	3	13	6	808	898	82 400	91 600	2 200	2 800				
	230	64	3	13	6	808	898	82 400	91 600	2 200	2 800				
230	80	3	12	5	958	1 130	97 700	115 000	1 700	2 300					
280	93	4	19	9	1 330	1 400	135 000	143 000	1 600	2 000					
280	93	4	19	9	1 330	1 400	135 000	143 000	1 600	2 000					

① Bearings appended with "K" have a tapered bore ratio of 1:12; bearings appended with "K30" have a tapered bore ratio 1:30. ② Smallest allowable dimension for chamfer dimension r*.

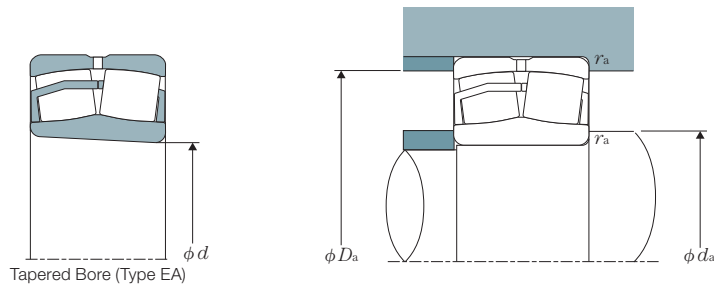

Dynamic Equivalent Radial Load

$$P_r = XF_r + YF_a$$

$\frac{F_a}{F_r} \leq e$		$\frac{F_a}{F_r} > e$	
X	Y	X	Y
1	Y_1	0.67	Y_2

Static Equivalent Radial Load

$$P_{0r} = F_r + Y_0 F_a$$

For values e , Y_1 , Y_2 and Y_0 see the following table.

Bearing Numbers		Abutment and Fillet Dimensions						Constant	Axial Load Factors			Mass (approx.)	
Cylindrical Bore	Tapered Bore [®]	d_1	$d_{a \min}$	$D_{a \max}$	D_1	$r_{as \max}$	e		Y_1	Y_2	Y_0	Cylindrical Bore	Tapered Bore
22218EAD1	22218EAKD1	105	101	149	144	2	0.23	2.90	4.31	2.83	3.34	3.27	
22218EMD1	22218EMKD1	105	101	149	144	2	0.23	2.90	4.31	2.83	3.43	3.37	
23218EMD1	23218EMKD1	104	101	149	141	2	0.30	2.25	3.34	2.20	4.43	4.31	
22318EAD1	22318EAKD1	110	104	176	166	3	0.33	2.06	3.06	2.01	8.42	8.25	
22318EMD1	22318EMKD1	110	104	176	166	3	0.33	2.06	3.06	2.01	8.53	8.35	
22219EAD1	22219EAKD1	110	107	158	153	2.1	0.23	2.95	4.40	2.89	3.98	3.90	
22219EMD1	22219EMKD1	110	107	158	153	2.1	0.23	2.95	4.40	2.89	4.06	3.98	
22319EAD1	22319EAKD1	120	109	186	174	3	0.32	2.09	3.11	2.04	9.91	9.71	
22319EMD1	22319EMKD1	120	109	186	174	3	0.32	2.09	3.11	2.04	10.0	9.82	
23120EAD1	23120EAKD1	114	111	154	147	2	0.28	2.39	3.56	2.34	4.37	4.24	
23120EMD1	23120EMKD1	114	111	154	147	2	0.28	2.39	3.56	2.34	4.45	4.32	
22220EAD1	22220EAKD1	118	112	168	161	2.1	0.24	2.84	4.23	2.78	4.90	4.80	
22220EMD1	22220EMKD1	118	112	168	161	2.1	0.24	2.84	4.23	2.78	5.02	4.93	
23220EMD1	23220EMKD1	118	112	168	159	2.1	0.31	2.18	3.24	2.13	6.51	6.33	
22320EAD1	22320EAKD1	127	114	201	187	3	0.34	1.98	2.94	1.93	12.6	12.3	
22320EMD1	22320EMKD1	127	114	201	187	3	0.34	1.98	2.94	1.93	12.9	12.7	
23022EAD1	23022EAKD1	123	119	161	155	2	0.23	2.95	4.40	2.89	3.66	3.55	
23022EMD1	23022EMKD1	123	119	161	155	2	0.23	2.95	4.40	2.89	3.66	3.55	
23122EAD1	23122EAKD1	125	121	169	161	2	0.28	2.43	3.61	2.37	5.66	5.49	
23122EMD1	23122EMKD1	125	121	169	161	2	0.28	2.43	3.61	2.37	5.53	5.36	
24122EMD1	24122EMK30D1	121	121	169	158	2	0.36	1.90	2.83	1.86	6.75	6.65	
22222EAD1	22222EAKD1	130	122	188	179	2.1	0.25	2.69	4.00	2.63	7.10	6.95	
22222EMD1	22222EMKD1	130	122	188	179	2.1	0.25	2.69	4.00	2.63	7.30	7.15	
23222EMD1	23222EMKD1	130	122	188	176	2.1	0.32	2.12	3.15	2.07	9.41	9.14	
22322EAD1	22322EAKD1	139	124	226	209	3	0.32	2.09	3.11	2.04	17.0	16.6	
22322EMD1	22322EMKD1	139	124	226	209	3	0.32	2.09	3.11	2.04	17.4	17.1	
23024EAD1	23024EAKD1	134	129	171	165	2	0.22	3.14	4.67	3.07	4.02	3.90	
23024EMD1	23024EMKD1	134	129	171	165	2	0.22	3.14	4.67	3.07	4.02	3.90	
24024EMD1	24024EMK30D1	132	129	171	161	2	0.29	2.32	3.45	2.26	5.28	5.21	
23124EAD1	23124EAKD1	138	131	189	179	2	0.28	2.43	3.61	2.37	7.72	7.49	
23124EMD1	23124EMKD1	138	131	189	179	2	0.28	2.43	3.61	2.37	7.77	7.54	
24124EMD1	24124EMK30D1	136	131	189	173	2	0.37	1.84	2.74	1.80	10.0	9.87	
22224EAD1	22224EAKD1	141	132	203	193	2.1	0.25	2.74	4.08	2.68	8.88	8.68	
22224EMD1	22224EMKD1	141	132	203	193	2.1	0.25	2.74	4.08	2.68	9.01	8.82	
23224EMD1	23224EMKD1	139	132	203	190	2.1	0.32	2.09	3.11	2.04	11.7	11.3	
22324EAD1	22324EAKD1	156	134	246	225	3	0.32	2.09	3.11	2.04	22.3	21.9	
22324EMD1	22324EMKD1	156	134	246	225	3	0.32	2.09	3.11	2.04	22.7	22.2	
23026EAD1	23026EAKD1	145	139	191	183	2	0.22	3.01	4.48	2.94	5.88	5.71	
23026EMD1	23026EMKD1	145	139	191	183	2	0.22	3.01	4.48	2.94	5.90	5.73	
24026EMD1	24026EMK30D1	143	139	191	178	2	0.31	2.20	3.27	2.15	7.82	7.71	
23126EAD1	23126EAKD1	148	141	199	189	2	0.27	2.51	3.74	2.45	8.45	8.19	
23126EMD1	23126EMKD1	148	141	199	189	2	0.27	2.51	3.74	2.45	8.51	8.25	
24126EMD1	24126EMK30D1	146	141	199	183	2	0.34	1.96	2.92	1.92	10.7	10.5	
22226EAD1	22226EAKD1	151	144	216	206	3	0.25	2.69	4.00	2.63	11.0	10.7	
22226EMD1	22226EMKD1	151	144	216	206	3	0.25	2.69	4.00	2.63	11.1	10.9	
23226EMD1	23226EMKD1	150	144	216	203	3	0.32	2.12	3.15	2.07	13.8	13.4	
22326EAD1	22326EAKD1	164	147	263	243	4	0.33	2.06	3.06	2.01	27.2	26.6	
22326EMD1	22326EMKD1	164	147	263	243	4	0.33	2.06	3.06	2.01	28.0	27.5	

ULTAGE Series Spherical Roller Bearings [Type EA, Type EM]

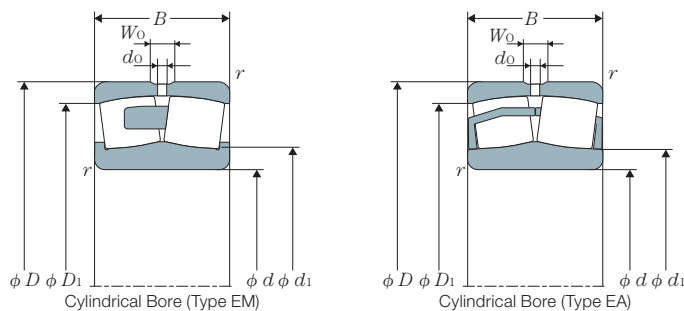

d	Boundary Dimensions					Basic Dynamic Load Rating Cr	Basic Static Load Rating Cor	Basic Dynamic Load Rating Cr	Basic Static Load Rating Cor	Limiting Speeds					
	mm									kN		kgf		min ⁻¹	
	D	B	r _s min ^②	Wo	do					Cr	Cor	Cr	Cor	Grease	Oil
140	210	53	2	9	4	597	783	60 900	79 800	2 100	2 700				
	210	53	2	9	4	597	783	60 900	79 800	2 100	2 700				
	210	69	2	9	4	709	990	72 300	101 000	1 800	2 200				
	225	68	2.1	11	5	802	1 030	81 800	105 000	1 800	2 200				
	225	68	2.1	11	5	802	1 030	81 800	105 000	1 800	2 200				
	225	85	2.1	10	4.5	951	1 280	97 000	130 000	1 700	2 200				
	250	68	3	14	7	912	1 010	93 000	103 000	2 000	2 500				
	250	68	3	14	7	912	1 010	93 000	103 000	2 000	2 500				
	250	88	3	13	6	1 140	1 370	116 000	139 000	1 600	2 100				
	300	102	4	19	9	1 540	1 720	157 000	175 000	1 500	1 900				
300	102	4	19	9	1 540	1 720	157 000	175 000	1 500	1 900					
150	225	56	2.1	10	4.5	660	893	67 300	91 100	2 000	2 500				
	225	56	2.1	10	4.5	660	893	67 300	91 100	2 000	2 500				
	225	75	2.1	10	4.5	789	1 140	80 400	116 000	1 700	2 100				
	250	80	2.1	13	6	1 060	1 350	108 000	138 000	1 600	2 000				
	250	80	2.1	13	6	1 060	1 350	108 000	138 000	1 600	2 000				
	250	100	2.1	12	6	1 180	1 590	121 000	162 000	1 600	2 000				
	270	73	3	15	7	1 080	1 220	110 000	124 000	1 800	2 300				
	270	73	3	15	7	1 080	1 220	110 000	124 000	1 800	2 300				
	270	96	3	14	6	1 340	1 620	137 000	165 000	1 500	1 900				
	320	108	4	20	9	1 740	1 890	178 000	193 000	1 400	1 700				
160	220	45	2	9	4	455	683	46 400	69 600	1 900	2 400				
	240	60	2.1	11	5	748	1 000	76 300	102 000	1 800	2 300				
	240	60	2.1	11	5	748	1 000	76 300	102 000	1 800	2 300				
	240	80	2.1	10	5	901	1 290	91 900	132 000	1 600	2 000				
	270	86	2.1	14	6	1 220	1 580	124 000	162 000	1 500	1 900				
	270	86	2.1	14	6	1 220	1 580	124 000	162 000	1 500	1 900				
	270	109	2.1	14	6	1 360	1 860	139 000	190 000	1 500	1 800				
	290	80	3	17	8	1 220	1 390	124 000	142 000	1 700	2 100				
	290	80	3	17	8	1 220	1 390	124 000	142 000	1 700	2 100				
	290	104	3	15	7	1 550	1 890	158 000	193 000	1 400	1 800				
	340	114	4	20	10	1 950	2 210	199 000	226 000	1 300	1 600				
170	230	45	2	9	4.5	468	723	47 700	73 700	1 800	2 300				
	260	67	2.1	12	5	914	1 240	93 200	127 000	1 700	2 200				
	260	67	2.1	12	5	914	1 240	93 200	127 000	1 700	2 200				
	260	90	2.1	11	5	1 100	1 600	112 000	163 000	1 500	1 900				
	280	88	2.1	14	6	1 270	1 700	129 000	173 000	1 400	1 800				
	280	88	2.1	14	6	1 270	1 700	129 000	173 000	1 400	1 800				
	280	109	2.1	14	6	1 410	1 990	144 000	203 000	1 400	1 700				
	310	86	4	18	8	1 400	1 610	143 000	164 000	1 600	2 000				
	310	110	4	16	8	1 700	2 070	173 000	211 000	1 300	1 700				
	360	120	4	20	10	2 200	2 630	225 000	268 000	1 200	1 500				

① Bearings appended with "K" have a tapered bore ratio of 1:12; bearings appended with "K30" have a tapered bore ratio 1:30. ② Smallest allowable dimension for chamfer dimension r.

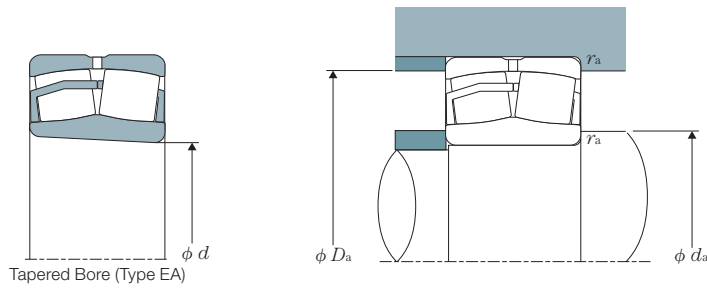

Dynamic Equivalent Radial Load

$$P_r = XF_r + YF_a$$

$\frac{F_a}{F_r} \leq e$		$\frac{F_a}{F_r} > e$	
X	Y	X	Y
1	Y_1	0.67	Y_2

Static Equivalent Radial Load

$$P_{0r} = F_r + Y_0 F_a$$

For values e , Y_1 , Y_2 and Y_0 see the following table.

Bearing Numbers		Abutment and Fillet Dimensions					Constant	Axial Load Factors			Mass (approx.)	
Cylindrical Bore	Tapered Bore [®]	d_1	d_a min	D_a max	D_1	r_{as} max	e	Y_1	Y_2	Y_0	kg	
											Cylindrical Bore	Tapered Bore
23028EAD1	23028EAKD1	155	149	201	193	2	0.22	3.14	4.67	3.07	6.32	6.13
23028EMD1	23028EMKD1	155	149	201	193	2	0.22	3.14	4.67	3.07	6.37	6.18
24028EMD1	24028EMK30D1	153	149	201	188	2	0.28	2.37	3.53	2.32	8.27	8.15
23128EAD1	23128EAKD1	159	152	213	203	2.1	0.26	2.55	3.80	2.50	10.3	9.94
23128EMD1	23128EMKD1	159	152	213	203	2.1	0.26	2.55	3.80	2.50	10.3	10.0
24128EMD1	24128EMK30D1	156	152	213	198	2.1	0.34	1.98	2.94	1.93	12.9	12.8
22228EAD1	22228EAKD1	163	154	236	224	3	0.25	2.74	4.08	2.68	13.9	13.6
22228EMD1	22228EMKD1	163	154	236	224	3	0.25	2.74	4.08	2.68	14.2	13.9
23228EMD1	23228EMKD1	162	154	236	220	3	0.33	2.06	3.06	2.01	18.2	17.7
22328EAD1	22328EAKD1	181	157	283	261	4	0.33	2.03	3.02	1.98	34.4	33.7
22328EMD1	22328EMKD1	181	157	283	261	4	0.33	2.03	3.02	1.98	35.4	34.7
23030EAD1	23030EAKD1	167	161	214	207	2.1	0.21	3.20	4.77	3.13	7.68	7.45
23030EMD1	23030EMKD1	167	161	214	207	2.1	0.21	3.20	4.77	3.13	7.73	7.50
24030EMD1	24030EMK30D1	165	161	214	202	2.1	0.29	2.32	3.45	2.26	10.4	10.3
23130EAD1	23130EAKD1	171	162	238	223	2.1	0.29	2.35	3.50	2.30	15.7	15.2
23130EMD1	23130EMKD1	171	162	238	223	2.1	0.29	2.35	3.50	2.30	15.8	15.3
24130EMD1	24130EMK30D1	168	162	238	216	2.1	0.36	1.85	2.76	1.81	19.7	19.4
22230EAD1	22230EAKD1	177	164	256	242	3	0.25	2.74	4.08	2.68	17.6	17.3
22230EMD1	22230EMKD1	177	164	256	242	3	0.25	2.74	4.08	2.68	18.0	17.7
23230EMD1	23230EMKD1	174	164	256	237	3	0.33	2.03	3.02	1.98	23.6	22.9
22330EMD1	22330EMKD1	188	167	303	279	4	0.34	2.00	2.98	1.96	42.2	41.3
23932EMD1	23932EMKD1	175	169	211	205	2	0.17	3.90	5.81	3.81	5.09	4.94
23032EAD1	23032EAKD1	177	171	229	221	2.1	0.21	3.20	4.77	3.13	9.32	9.03
23032EMD1	23032EMKD1	177	171	229	221	2.1	0.21	3.20	4.77	3.13	9.37	9.09
24032EMD1	24032EMK30D1	175	171	229	215	2.1	0.29	2.32	3.45	2.26	12.6	12.4
23132EAD1	23132EAKD1	185	172	258	240	2.1	0.29	2.35	3.50	2.30	20.1	19.5
23132EMD1	23132EMKD1	185	172	258	240	2.1	0.29	2.35	3.50	2.30	20.2	19.6
24132EMD1	24132EMK30D1	181	172	258	232	2.1	0.37	1.83	2.72	1.79	25.4	25.1
22232EAD1	22232EAKD1	190	174	276	260	3	0.25	2.69	4.00	2.63	22.3	21.8
22232EMD1	22232EMKD1	190	174	276	260	3	0.25	2.69	4.00	2.63	22.9	22.4
23232EMD1	23232EMKD1	187	174	276	254	3	0.33	2.03	3.02	1.98	29.6	28.8
22332EMD1	22332EMKD1	205	177	323	296	4	0.33	2.03	3.02	1.98	50.5	49.5
23934EMD1	23934EMKD1	185	179	221	215	2	0.16	4.11	6.12	4.02	5.39	5.23
23034EAD1	23034EAKD1	190	181	249	238	2.1	0.22	3.07	4.57	3.00	12.7	12.3
23034EMD1	23034EMKD1	190	181	249	238	2.1	0.22	3.07	4.57	3.00	12.8	12.4
24034EMD1	24034EMK30D1	186	181	249	231	2.1	0.30	2.23	3.32	2.18	17.2	16.9
23134EAD1	23134EAKD1	195	182	268	250	2.1	0.28	2.39	3.56	2.34	21.5	20.9
23134EMD1	23134EMKD1	195	182	268	250	2.1	0.28	2.39	3.56	2.34	21.6	20.9
24134EMD1	24134EMK30D1	193	182	268	243	2.1	0.35	1.91	2.85	1.87	26.7	26.3
22234EMD1	22234EMKD1	201	187	293	277	4	0.26	2.60	3.87	2.54	28.3	27.7
23234EMD1	23234EMKD1	199	187	293	272	4	0.33	2.03	3.02	1.98	35.8	34.8
22334EMD1	22334EMKD1	223	187	343	313	4	0.32	2.09	3.11	2.04	60.3	59.1

ULTAGE Series Spherical Roller Bearings [Type EA, Type EM]

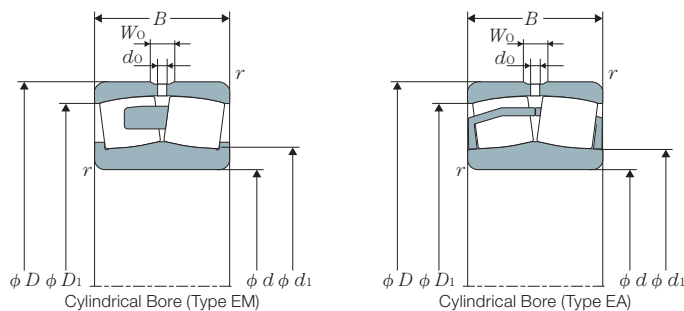

d	Boundary Dimensions					Basic Dynamic Load Rating Cr	Basic Static Load Rating Cor	Basic Dynamic Load Rating Cr	Basic Static Load Rating Cor	Limiting Speeds					
	mm									kN		kgf		min ⁻¹	
	D	B	r _s min ^②	Wo	do					Cr	Cor	Cr	Cor	Grease	Oil
180	250	52	2	10	5	573	869	58 400	88 600	1 700	2 100				
	280	74	2.1	13	6	1 080	1 450	110 000	148 000	1 600	2 000				
	280	74	2.1	13	6	1 080	1 450	110 000	148 000	1 600	2 000				
	280	100	2.1	13	6	1 310	1 880	133 000	192 000	1 400	1 800				
	300	96	3	15	7	1 490	1 960	152 000	200 000	1 300	1 700				
	300	96	3	15	7	1 490	1 960	152 000	200 000	1 300	1 700				
	300	118	3	15	7	1 660	2 290	169 000	233 000	1 300	1 600				
	320	86	4	18	8	1 450	1 660	148 000	169 000	1 500	1 900				
	320	112	4	16	8	1 800	2 270	183 000	231 000	1 200	1 600				
	380	126	4	21	10	2 420	2 810	247 000	286 000	1 100	1 400				
190	260	52	2	10	5	603	935	61 500	95 400	1 600	2 000				
	290	75	2.1	13	6	1 140	1 570	116 000	160 000	1 500	1 900				
	290	75	2.1	13	6	1 140	1 570	116 000	160 000	1 500	1 900				
	290	100	2.1	13	6	1 360	2 000	138 000	204 000	1 300	1 700				
	320	104	3	17	8	1 670	2 250	170 000	230 000	1 200	1 600				
	320	128	3	16	8	1 900	2 700	194 000	275 000	1 200	1 500				
	340	92	4	20	9	1 620	1 870	165 000	191 000	1 400	1 800				
	340	120	4	18	8	1 990	2 480	203 000	253 000	1 200	1 500				
	400	132	5	21	10	2 600	3 120	265 000	318 000	1 000	1 300				
200	280	60	2.1	12	6	766	1 190	78 100	121 000	1 500	1 900				
	310	82	2.1	15	7	1 310	1 790	134 000	182 000	1 400	1 800				
	310	109	2.1	14	7	1 570	2 280	160 000	233 000	1 200	1 600				
	340	112	3	18	8	1 890	2 510	192 000	256 000	1 100	1 400				
	340	140	3	17	8	2 130	2 930	218 000	299 000	1 100	1 400				
	360	98	4	20	10	1 810	2 100	184 000	214 000	1 400	1 700				
	360	128	4	19	9	2 250	2 840	230 000	290 000	1 100	1 300				
	420	138	5	21	10	2 830	3 530	289 000	360 000	950	1 200				
220	300	60	2.1	12	6	789	1 260	80 500	128 000	1 400	1 700				
	340	90	3	15	7	1 530	2 110	156 000	215 000	1 300	1 600				
	340	118	3	15	7	1 850	2 720	189 000	278 000	1 100	1 400				
	370	120	4	19	9	2 190	2 940	223 000	300 000	1 000	1 300				
	370	150	4	19	9	2 540	3 620	259 000	369 000	1 000	1 300				
	400	108	4	21	11	2 210	2 690	225 000	274 000	1 200	1 500				
	400	144	4	20	10	2 890	3 830	295 000	391 000	1 000	1 200				
240	320	60	2.1	12	6	815	1 350	83 100	138 000	1 300	1 600				
	360	92	3	16	8	1 630	2 350	166 000	240 000	1 100	1 400				
	360	118	3	16	8	1 940	2 980	198 000	304 000	1 000	1 300				
	400	128	4	20	9	2 510	3 500	256 000	357 000	960	1 200				
	400	160	4	19	9	2 910	4 290	297 000	438 000	960	1 200				
260	360	75	2.1	14	7	1 130	1 940	115 000	198 000	1 100	1 400				
	400	104	4	18	8	2 060	2 910	210 000	297 000	1 000	1 300				
	400	140	4	18	8	2 520	3 820	257 000	390 000	960	1 200				
280	380	75	2.1	14	7	1 180	2 050	120 000	209 000	1 000	1 300				
	420	106	4	18	8	2 170	3 150	221 000	321 000	960	1 200				
	420	140	4	18	8	2 620	4 060	267 000	414 000	880	1 100				

① Bearings appended with "K" have a tapered bore ratio of 1:12; bearings appended with "K30" have a tapered bore ratio 1:30. ② Smallest allowable dimension for chamfer dimension r.

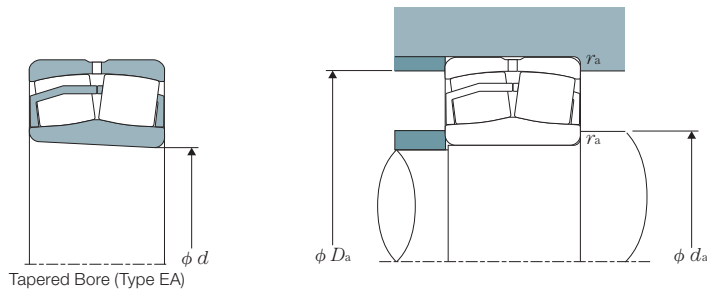

Dynamic Equivalent Radial Load

$$P_r = XF_r + YF_a$$

$\frac{F_a}{F_r} \leq e$		$\frac{F_a}{F_r} > e$	
X	Y	X	Y
1	Y_1	0.67	Y_2

Static Equivalent Radial Load

$$P_{0r} = F_r + Y_0 F_a$$

For values e , Y_1 , Y_2 and Y_0 see the following table.

Bearing Numbers		Abutment and Fillet Dimensions					Constant	Axial Load Factors			Mass (approx.)	
Cylindrical Bore	Tapered Bore [®]	d_1	$d_{a \text{ min}}$	$D_{a \text{ max}}$	D_1	$r_{as \text{ max}}$	e	Y_1	Y_2	Y_0	kg	
											Cylindrical Bore	Tapered Bore
23936EMD1	23936EMKD1	199	189	241	232	2	0.17	3.90	5.81	3.81	7.79	7.56
23036EAD1	23036EAKD1	201	191	269	255	2.1	0.23	2.95	4.40	2.89	16.8	16.3
23036EMD1	23036EMKD1	201	191	269	255	2.1	0.23	2.95	4.40	2.89	16.9	16.4
24036EMD1	24036EMK30D1	199	191	269	248	2.1	0.31	2.15	3.20	2.10	22.8	22.4
23136EAD1	23136EAKD1	205	194	286	267	3	0.29	2.32	3.45	2.26	27.2	26.4
23136EMD1	23136EMKD1	205	194	286	267	3	0.29	2.32	3.45	2.26	27.4	26.5
24136EMD1	24136EMK30D1	202	194	286	259	3	0.36	1.87	2.79	1.83	33.5	33.0
22236EMD1	22236EMKD1	209	197	303	287	4	0.25	2.74	4.08	2.68	29.3	28.7
23236EMD1	23236EMKD1	210	197	303	282	4	0.33	2.06	3.06	2.01	38.2	37.1
22336EMD1	22336EMKD1	229	197	363	329	4	0.32	2.09	3.11	2.04	70.2	68.7
23938EMD1	23938EMKD1	209	199	251	243	2	0.17	4.05	6.04	3.96	8.20	7.96
23038EAD1	23038EAKD1	213	201	279	266	2.1	0.22	3.01	4.48	2.94	17.8	17.3
23038EMD1	23038EMKD1	213	201	279	266	2.1	0.22	3.01	4.48	2.94	17.9	17.4
24038EMD1	24038EMK30D1	209	201	279	258	2.1	0.30	2.23	3.32	2.18	23.8	23.4
23138EMD1	23138EMKD1	221	204	306	284	3	0.29	2.32	3.45	2.26	34.3	33.2
24138EMD1	24138EMK30D1	216	204	306	275	3	0.37	1.84	2.74	1.80	42.1	41.5
22238EMD1	22238EMKD1	222	207	323	305	4	0.25	2.74	4.08	2.68	35.6	34.9
23238EMD1	23238EMKD1	220	207	323	299	4	0.33	2.03	3.02	1.98	46.1	44.7
22338EMD1	22338EMKD1	247	210	380	346	5	0.32	2.12	3.15	2.07	81.5	79.9
23940EMD1	23940EMKD1	221	211	269	260	2.1	0.18	3.76	5.59	3.67	12.0	11.6
23040EMD1	23040EMKD1	223	211	299	283	2.1	0.23	2.95	4.40	2.89	22.8	22.1
24040EMD1	24040EMK30D1	221	211	299	275	2.1	0.31	2.18	3.24	2.13	30.2	29.7
23140EMD1	23140EMKD1	231	214	326	301	3	0.30	2.25	3.34	2.20	41.9	40.6
24140EMD1	24140EMK30D1	224	214	326	291	3	0.39	1.74	2.59	1.70	51.5	50.7
22240EMD1	22240EMKD1	234	217	343	323	4	0.25	2.74	4.08	2.68	42.7	41.8
23240EMD1	23240EMKD1	232	217	343	315	4	0.34	1.98	2.94	1.93	55.2	53.6
22340EMD1	22340EMKD1	265	220	400	364	5	0.31	2.15	3.20	2.10	94.6	92.7
23944EMD1	23944EMKD1	241	231	289	280	2.1	0.17	4.05	6.04	3.96	12.5	12.1
23044EMD1	23044EMKD1	246	233	327	310	3	0.23	2.95	4.40	2.89	29.9	29.1
24044EMD1	24044EMK30D1	243	233	327	302	3	0.31	2.20	3.27	2.15	39.2	38.6
23144EMD1	23144EMKD1	252	237	353	328	4	0.30	2.28	3.39	2.23	52.3	50.7
24144EMD1	24144EMK30D1	247	237	353	317	4	0.38	1.78	2.65	1.74	65.2	64.3
22244EMD1	22244EMKD1	264	237	383	358	4	0.25	2.74	4.08	2.68	59.6	58.4
23244EMD1	23244EMKD1	261	237	383	349	4	0.34	2.00	2.98	1.96	79.4	77.1
23948EMD1	23948EMKD1	262	251	309	301	2.1	0.15	4.40	6.56	4.31	13.5	13.1
23048EMD1	23048EMKD1	267	253	347	329	3	0.22	3.07	4.57	3.00	32.0	31.7
24048EMD1	24048EMK30D1	264	253	347	322	3	0.28	2.37	3.53	2.32	42.2	41.6
23148EMD1	23148EMKD1	276	257	383	356	4	0.29	2.32	3.45	2.26	65.1	63.1
24148EMD1	24148EMK30D1	270	257	383	344	4	0.37	1.82	2.70	1.78	81.0	79.8
23952EMD1	23952EMKD1	292	271	349	335	2.1	0.17	3.90	5.81	3.81	23.9	23.1
23052EMD1	23052EMKD1	291	275	385	366	4	0.23	2.95	4.40	2.89	47.8	46.3
24052EMD1	24052EMK30D1	286	275	385	354	4	0.31	2.16	3.22	2.12	63.6	62.6
23956EMD1	23956EMKD1	310	291	369	356	2.1	0.16	4.16	6.20	4.07	25.2	24.4
23056EMD1	23056EMKD1	310	295	405	386	4	0.22	3.07	4.57	3.00	51.3	49.7
24056EMD1	24056EMK30D1	306	295	405	376	4	0.29	2.30	3.42	2.25	67.3	66.3

ULTAGE Series Spherical Roller Bearings [Type EM (Large Size)]

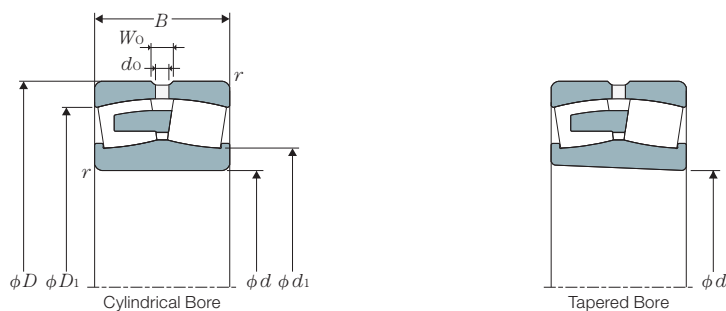

d	Boundary Dimensions					Basic Dynamic Load Rating Cr	Basic Static Load Rating Cor	Basic Dynamic Load Rating Cr	Basic Static Load Rating Cor	Limiting Speeds					
	mm									kN		kgf		min ⁻¹	
	D	B	r _s min ^②	Wo	do					Cr	Cor	Cr	Cor	Grease	Oil
220	460	145	5	20	12	3 010	3 560	307 000	363 000	850	1 090				
240	440	120	4	16	10	2 470	3 110	252 000	317 000	1060	1 350				
	440	160	4	20	12	3 140	4 260	320 000	435 000	850	1 090				
	500	155	5	20	12	3 500	4 170	357 000	425 000	780	1 000				
260	440	144	4	20	12	2 780	4 020	283 000	410 000	860	1 090				
	440	180	4	27	16	3 290	4 880	335 000	497 000	850	1 090				
	480	130	5	20	12	2 890	3 680	295 000	375 000	970	1 240				
	480	174	5	27	16	3 650	5 050	372 000	515 000	780	1 000				
	540	165	6	27	16	4 020	4 830	410 000	493 000	720	920				
280	460	146	5	20	12	2 980	4 400	304 000	448 000	810	1 030				
	460	180	5	27	16	3 550	5 450	362 000	556 000	810	1 030				
	500	130	5	20	12	3 010	3 920	306 000	400 000	920	1 180				
	500	176	5	27	16	3 810	5 420	389 000	552 000	740	950				
	580	175	6	27	16	4 490	5 450	458 000	556 000	670	860				
300	420	90	3	14	8	1 600	2 620	163 000	267 000	890	1 140				
	460	118	4	16	10	2 400	3 610	245 000	368 000	890	1 130				
	460	160	4	20	12	3 150	5 190	322 000	529 000	760	970				
	500	160	5	20	12	3 540	5 170	361 000	527 000	750	950				
	500	200	5	27	16	4 270	6 610	435 000	674 000	750	950				
	540	140	5	20	12	3 470	4 590	354 000	468 000	860	1 080				
	540	192	5	27	16	4 520	6 280	461 000	640 000	690	880				
320	440	90	3	14	8	1 670	2 820	170 000	288 000	840	1 080				
	480	121	4	20	12	2 540	4 020	259 000	409 000	850	1 070				
	480	160	4	20	12	3 250	5 400	331 000	551 000	720	920				
	540	176	5	27	16	4 020	6 020	410 000	614 000	700	880				
	540	218	5	33	20	5 010	7 720	511 000	787 000	690	880				
	580	150	5	20	12	3 950	5 100	403 000	520 000	800	1 020				
	580	208	5	33	20	5 230	7 370	534 000	751 000	640	820				
340	460	90	3	14	8	1 710	2 980	174 000	304 000	800	1 020				
	520	133	5	20	12	2 990	4 690	305 000	479 000	790	1 000				
	520	180	5	27	16	3 910	6 510	398 000	664 000	670	860				
	580	190	5	27	16	4 670	6 870	476 000	701 000	650	830				
	580	243	5	33	20	5 980	9 340	610 000	953 000	650	830				
360	480	90	3	14	8	1 750	3 090	178 000	316 000	760	970				
	540	134	5	20	12	3 070	4 910	313 000	500 000	750	950				
	540	180	5	27	16	4 040	6 840	412 000	698 000	640	820				
380	520	106	4	16	10	2 300	3 920	235 000	400 000	710	910				
	560	135	5	20	12	3 230	5 270	330 000	538 000	720	910				
	560	180	5	27	16	4 140	7 280	422 000	742 000	610	780				
400	540	106	4	16	10	2 370	4 170	241 000	425 000	680	870				
420	560	106	4	16	10	2 390	4 320	244 000	441 000	650	830				

① Bearings appended with "K" have a tapered bore ratio of 1:12; bearings appended with "K30" have a tapered bore ratio 1:30. ② Smallest allowable dimension for chamfer dimension r*.

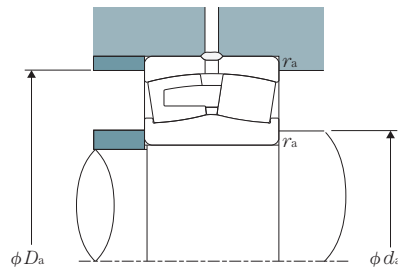

Dynamic Equivalent Radial Load

$$P_r = XF_r + YF_a$$

$\frac{F_a}{F_r} \leq e$		$\frac{F_a}{F_r} > e$	
X	Y	X	Y
1	Y_1	0.67	Y_2

Static Equivalent Radial Load

$$P_{0r} = F_r + Y_0 F_a$$

For values e , Y_1 , Y_2 and Y_0 see the following table.

Bearing Numbers		Abutment and Fillet Dimensions					Constant	Axial Load Factors			Mass (approx.) kg	
Cylindrical Bore	Tapered Bore [®]	d_1	d_a min	D_a max	D_1	r_{as} max	e	Y_1	Y_2	Y_0	Cylindrical Bore	Tapered Bore
22344EMD1	22344EMKD1	277	240	440	388	5	0.32	2.10	3.13	2.06	119	116
22248EMD1	22248EMKD1	288	257	423	383	4	0.27	2.53	3.77	2.47	82.6	80.9
23248EMD1	23248EMKD1	284	257	423	372	4	0.36	1.86	2.77	1.82	108	105
22348EMD1	22348EMKD1	299	260	480	421	5	0.32	2.12	3.15	2.07	149	146
23152EMD1	23152EMKD1	302	277	423	380	4	0.31	2.15	3.20	2.10	92.2	89.5
24152EMD1	24152EMK30D1	295	277	423	371	4	0.40	1.69	2.52	1.65	111	109
22252EMD1	22252EMKD1	312	280	460	415	5	0.27	2.53	3.77	2.47	108	105
23252EMD1	23252EMKD1	310	280	460	405	5	0.36	1.87	2.79	1.83	143	139
22352EMD1	22352EMKD1	324	286	514	456	6	0.31	2.16	3.22	2.12	186	183
23156EMD1	23156EMKD1	322	300	440	403	5	0.30	2.23	3.32	2.18	98.4	95.3
24156EMD1	24156EMK30D1	316	300	440	394	5	0.38	1.78	2.65	1.74	118	117
22256EMD1	22256EMKD1	333	300	480	437	5	0.25	2.69	4.00	2.63	113	111
23256EMD1	23256EMKD1	331	300	480	426	5	0.35	1.95	2.90	1.91	152	148
22356EMD1	22356EMKD1	349	306	554	489	6	0.31	2.18	3.24	2.13	228	223
23960EMD1	23960EMKD1	329	313	407	387	3	0.20	3.42	5.09	3.34	40.1	39.2
23060EMD1	23060EMKD1	338	315	445	413	4	0.24	2.81	4.19	2.75	72.9	70.9
24060EMD1	24060EMK30D1	332	315	445	401	4	0.33	2.04	3.04	2.00	98.0	96.9
23160EMD1	23160EMKD1	345	320	480	436	5	0.31	2.20	3.27	2.15	129	125
24160EMD1	24160EMK30D1	340	320	480	425	5	0.39	1.74	2.59	1.70	159	157
22260EMD1	22260EMKD1	358	320	520	469	5	0.25	2.69	4.00	2.63	134	131
23260EMD1	23260EMKD1	352	320	520	461	5	0.35	1.92	2.86	1.88	194	188
23964EMD1	23964EMKD1	350	333	427	407	3	0.19	3.62	5.39	3.54	42.1	40.8
23064EMD1	23064EMKD1	360	335	465	433	4	0.23	2.92	4.35	2.86	78.9	76.6
24064EMD1	24064EMK30D1	352	335	465	423	4	0.31	2.15	3.20	2.10	104	102
23164EMD1	23164EMKD1	373	340	520	468	5	0.31	2.15	3.20	2.10	169	164
24164EMD1	24164EMK30D1	363	340	520	457	5	0.39	1.71	2.54	1.67	204	201
22264EMD1	22264EMKD1	383	340	560	510	5	0.25	2.69	4.00	2.63	177	174
23264EMD1	23264EMKD1	376	340	560	493	5	0.35	1.91	2.85	1.87	245	238
23968EMD1	23968EMKD1	370	353	447	427	3	0.18	3.80	5.66	3.72	44.5	43.1
23068EMD1	23068EMKD1	384	358	502	466	5	0.24	2.87	4.27	2.80	98.5	95.5
24068EMD1	24068EMK30D1	377	358	502	456	5	0.33	2.06	3.06	2.01	140	137
23168EMD1	23168EMKD1	393	360	560	500	5	0.32	2.12	3.15	2.07	213	206
24168EMD1	24168EMK30D1	385	360	560	486	5	0.41	1.65	2.46	1.61	266	262
23972EMD1	23972EMKD1	390	373	467	447	3	0.17	4.00	5.96	3.91	46.2	44.8
23072EMD1	23072EMKD1	405	378	522	488	5	0.23	2.98	4.44	2.92	111	108
24072EMD1	24072EMK30D1	398	378	522	478	5	0.31	2.16	3.22	2.12	147	145
23976EMD1	23976EMKD1	412	395	505	481	4	0.18	3.66	5.46	3.58	68.0	65.9
23076EMD1	23076EMKD1	425	398	542	509	5	0.22	3.07	4.57	3.00	117	113
24076EMD1	24076EMK30D1	420	398	542	499	5	0.30	2.25	3.34	2.20	154	151
23980EMD1	23980EMKD1	433	415	525	501	4	0.18	3.80	5.66	3.72	71.4	69.2
23984EMD1	23984EMKD1	454	435	545	522	4	0.17	3.95	5.88	3.86	74.9	72.6

Bearing Number

223	20	EMA	K	D1	VS1
------------	-----------	------------	----------	-----------	------------

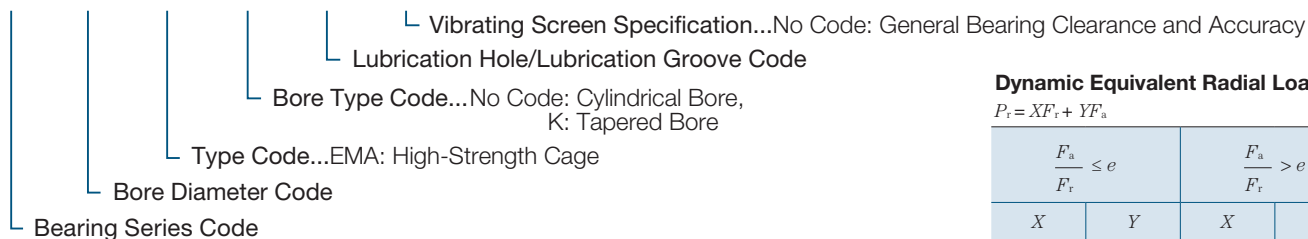

Dynamic Equivalent Radial Load

$$P_r = XF_r + YF_a$$

$\frac{F_a}{F_r} \leq e$		$\frac{F_a}{F_r} > e$	
X	Y	X	Y
1	Y_1	0.67	Y_2

Static Equivalent Radial Load

$$P_{or} = F_r + Y_o F_a$$

For values e , Y_1 , Y_2 and Y_o see the following table.

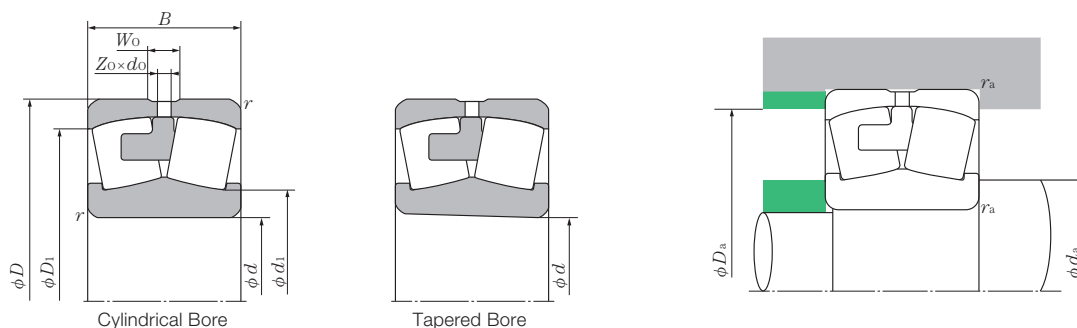

Boundary Dimensions						Basic Dynamic Load Rating	Basic Static Load Rating	Basic Dynamic Load Rating	Basic Static Load Rating	Limiting Speeds min ⁻¹ Oil
mm						kN		kgf		
d	D	B	r _{s min} ^②	W ₀	d _o	C _r	C _{or}	C _r	C _{or}	
70	150	51	2.1	10	5	397	368	40 500	37 500	4 700
75	160	55	2.1	10	5	464	434	47 400	44 200	4 400
80	170	58	2.1	10	5	512	485	52 200	49 400	4 100
85	180	60	3	11	5	538	524	54 900	53 400	3 900
90	190	64	3	12	5	632	605	64 500	61 700	3 700
95	200	67	3	12	6	658	650	67 000	66 300	3 500
100	215	73	3	13	6	743	731	75 700	74 600	3 300
110	240	80	3	16	7	869	833	88 600	84 900	3 000
120	260	86	3	18	8	1 060	1 120	108 000	114 000	2 700
130	280	93	4	19	9	1 260	1 310	129 000	134 000	2 500
140	300	102	4	19	9	1 400	1 500	142 000	153 000	2 400
150	320	108	4	20	9	1 570	1 640	160 000	167 000	2 200
160	340	114	4	20	10	1 760	1 940	180 000	198 000	2 100
170	360	120	4	20	10	2 010	2 320	205 000	237 000	1 900
180	380	126	4	21	10	2 190	2 460	223 000	250 000	1 800
190	400	132	5	21	10	2 370	2 750	242 000	281 000	1 700
200	420	138	5	21	10	2 590	3 140	265 000	320 000	1 600

① "K" indicates bearings have tapered bore with a taper ratio of 1:12. ② Smallest allowable dimension for chamfer dimension r.

Vibrating Screen Specification (VS Specifications)

Bearing specification suitable for vibrating screen applications.

The inner and outer diameter tolerances and radial internal clearances of these bearing specifications are set to the correct operating clearances for vibrating screen applications.

Units : mm

Single Plane mean Bore Diameter Deviation			Single Plane mean Outside Diameter Deviation				Radial internal Clearance (Cylindrical Bore)						
Nominal Bore Diameter		VS1, VS2		Nominal Outside Diameter		VS1, VS2		Nominal Bore Diameter		VS1		VS2	
over	incl.	high	low	over	incl.	high	low	over	incl.	min.	max.	min.	max.
	80	0	-0.010	150		-0.005	-0.013	65	65	0.075	0.090	0.100	0.120
80	120	0	-0.013	150	180	-0.005	-0.018	65	80	0.090	0.110	0.120	0.145
120	180	0	-0.015	180	315	-0.010	-0.023	80	100	0.110	0.135	0.150	0.180
180	200	0	-0.018	315	400	-0.013	-0.028	100	120	0.135	0.160	0.180	0.210
				400	420	-0.014	-0.030	120	140	0.160	0.190	0.205	0.240
								140	160	0.190	0.220	0.240	0.280
								160	180	0.200	0.240	0.260	0.310
								180	200	0.220	0.260	0.285	0.340

Number of Lubrication Holes

Nominal Outside Diameter mm		Number of Lubrication Holes
Min.	less than	
—	320	D1 Z ₀ 4
320	420 ¹⁾	8

1) 420 mm is included in this size class.

Bearing Numbers		Abutment and Fillet Dimensions					Constant	Axial Load Factors			Mass (approx.)	
Cylindrical Bore	Tapered Bore [®]	d_1	$d_a \text{ min}$	$D_a \text{ max}$	D_1	$r_{as \text{ max}}$		e	Y_1	Y_2	Y_0	kg Cylindrical Bore
22314EMAD1	22314EMAKD1	85	82	138	131	2.1	0.34	2.00	2.98	1.96	4.34	4.25
22315EMAD1	22315EMAKD1	91	87	148	139	2.1	0.34	2.00	2.98	1.96	5.30	5.19
22316EMAD1	22316EMAKD1	98	92	158	148	2.1	0.34	2.00	2.98	1.96	6.32	6.19
22317EMAD1	22317EMAKD1	107	99	166	157	3	0.32	2.09	3.11	2.04	7.19	7.05
22318EMAD1	22318EMAKD1	110	104	176	166	3	0.33	2.06	3.06	2.01	8.58	8.41
22319EMAD1	22319EMAKD1	120	109	186	174	3	0.32	2.09	3.11	2.04	9.80	9.60
22320EMAD1	22320EMAKD1	127	114	201	187	3	0.34	1.98	2.94	1.93	12.8	12.5
22322EMAD1	22322EMAKD1	139	124	226	209	3	0.32	2.09	3.11	2.04	17.3	16.9
22324EMAD1	22324EMAKD1	156	134	246	225	3	0.32	2.09	3.11	2.04	22.5	22.0
22326EMAD1	22326EMAKD1	164	147	263	243	4	0.33	2.06	3.06	2.01	28.4	27.8
22328EMAD1	22328EMAKD1	181	157	283	261	4	0.33	2.03	3.02	1.98	34.6	33.8
22330EMAD1	22330EMAKD1	188	167	303	279	4	0.34	2.00	2.98	1.96	41.9	41.0
22332EMAD1	22332EMAKD1	205	177	323	296	4	0.33	2.03	3.02	1.98	50.1	49.1
22334EMAD1	22334EMAKD1	223	187	343	313	4	0.32	2.09	3.11	2.04	59.7	58.5
22336EMAD1	22336EMAKD1	229	197	363	329	4	0.32	2.09	3.11	2.04	69.3	67.9
22338EMAD1	22338EMAKD1	247	210	380	346	5	0.32	2.12	3.15	2.07	81.0	79.4
22340EMAD1	22340EMAKD1	265	220	400	364	5	0.31	2.15	3.20	2.10	94.1	92.2

Bearing Number

WA	222	20	EA	LLS	K	D1	C3
-----------	------------	-----------	-----------	------------	----------	-----------	-----------

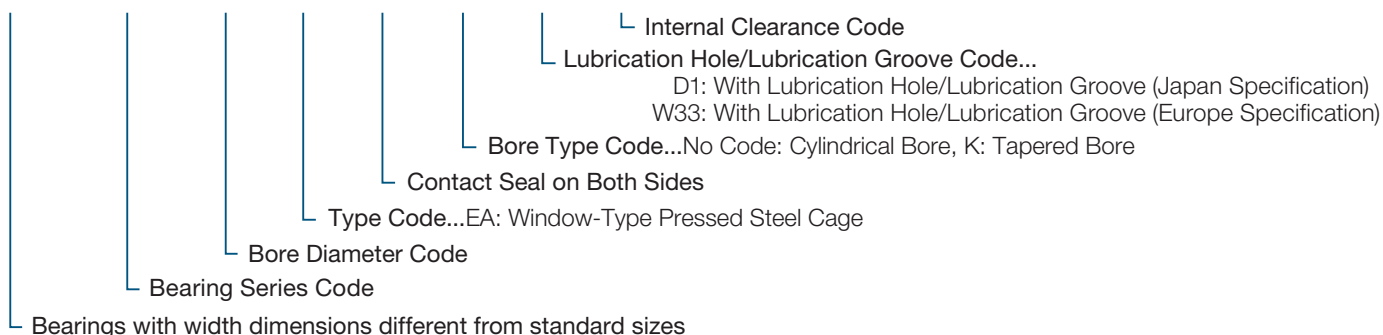

Boundary Dimensions						Basic Dynamic Load Rating	Basic Static Load Rating	Basic Dynamic Load Rating	Basic Static Load Rating	Bearing Numbers	
mm						kN		kgf		Cylindrical Bore	Tapered Bore ^①
<i>d</i>	<i>D</i>	<i>B</i>	<i>r_{s min}</i> ^②	<i>W_o</i>	<i>d_o</i>	<i>C_r</i>	<i>C_{or}</i>	<i>C_r</i>	<i>C_{or}</i>		
25	52	23	1	3	1.5	57.3	46.1	5 840	4 700	WA22205EALLSW33	—
30	62	25	1	4	2	75.7	64.5	7 720	6 580	WA22206EALLSW33	—
35	72	28	1.1	5	2	100	92	10 200	9 380	WA22207EALLSW33	WA22207EALLSKW33
40	80	28	1.1	5	2.5	116	105	11 800	10 700	WA22208EALLSD1	WA22208EALLSKD1
45	85	28	1.1	6	2.5	121	113	12 300	11 500	WA22209EALLSD1	WA22209EALLSKD1
50	90	28	1.1	6	2.5	130	124	13 300	12 600	WA22210EALLSD1	WA22210EALLSKD1
55	100	31	1.5	6	3	155	148	15 800	15 100	WA22211EALLSD1	WA22211EALLSKD1
60	110	34	1.5	7	3	187	181	19 100	18 400	WA22212EALLSD1	WA22212EALLSKD1
65	120	38	1.5	8	3.5	226	224	23 100	22 900	WA22213EALLSD1	WA22213EALLSKD1
70	125	38	1.5	7	3.5	235	240	24 000	24 400	WA22214EALLSD1	WA22214EALLSKD1
75	130	38	1.5	7	3.5	244	249	24 800	25 400	WA22215EALLSD1	WA22215EALLSKD1
80	140	40	2	8	3.5	278	287	28 400	29 300	WA22216EALLSD1	WA22216EALLSKD1
85	150	44	2	8	3.5	324	330	33 000	33 600	WA22217EALLSD1	WA22217EALLSKD1
90	160	48	2	10	4.5	384	398	39 200	40 600	WA22218EALLSD1	WA22218EALLSKD1
100	180	55	2.1	11	5	472	495	48 100	50 500	WA22220EALLSD1	WA22220EALLSKD1
110	200	63	2.1	12	6	602	643	61 400	65 600	WA22222EALLSD1	WA22222EALLSKD1
120	215	69	2.1	12	6	688	753	70 100	76 800	WA22224EALLSD1	WA22224EALLSKD1
130	230	75	3	13	6	808	898	82 400	91 600	WA22226EALLSD1	WA22226EALLSKD1

① "K" indicates bearings have tapered bore with a taper ratio of 1:12. ② Smallest allowable dimension for chamfer dimension *r*.

Handling Precautions

1. Because the internal radial clearance of "ULTAGE Series Sealed Spherical Roller Bearings" with tapered bores cannot be measured with a feeler gauge, please monitor clearances by measuring the axial movement of the inner ring as shown in Table 1.

2. During assembly, if misalignment exceeding the allowable misalignment angle of $\pm 0.5^\circ$ is applied to the bearing, rollers may come in direct contact with seals causing seal deformation. Furthermore, if additional force is applied under these conditions, seals may separate from the bearing entirely. Therefore, caution is advised.

3. Please use Lithium based grease. In case other types of grease are to be used, please consult **NTN**.

4. If a shrink fit is to be applied, please do not exceed a bearing temperature of 100 °C. Note that these bearings cannot be shrink fit via immersion in a hot oil bath.

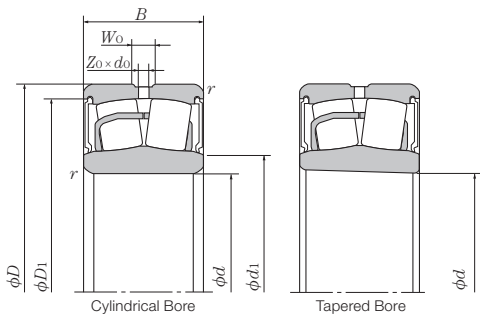

Number of Lubrication Holes

Z ₀	
D1	W33
4	3

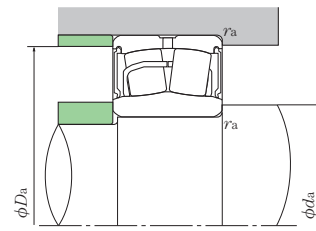

Dynamic Equivalent Radial Load

$$P_r = XF_r + YF_a$$

$\frac{F_a}{F_r} \leq e$		$\frac{F_a}{F_r} > e$	
X	Y	X	Y
1	Y ₁	0.67	Y ₂

Static Equivalent Radial Load

$$P_{or} = F_r + Y_o F_a$$

For values e , Y_1 , Y_2 and Y_o see the following table.

Abutment and Fillet Dimensions					Constant	Axial Load Factors			Mass (approx.)		Amount of Grease (approx.)
d_1	$d_a \text{ min}$	$D_a \text{ max}$	D_1	$r_{as \text{ max}}$		e	Y_1	Y_2	Y_o	kg	
									Cylindrical Bore	Tapered Bore	
29	29	47	47	1	0.34	2.00	2.98	1.96	0.19	–	1.4 ~ 2.4
36	36	56	56	1	0.31	2.15	3.20	2.10	0.30	–	2.0 ~ 3.3
43	42	65	65	1.1	0.31	2.21	3.29	2.16	0.50	0.49	2.3 ~ 3.9
48	47	73	73	1.1	0.27	2.47	3.67	2.41	0.58	0.57	3.1 ~ 5.2
53	52	78	78	1.1	0.26	2.64	3.93	2.58	0.63	0.61	3.4 ~ 5.7
58	57	83	83	1.1	0.24	2.84	4.23	2.78	0.70	0.68	3.4 ~ 5.6
64	64	93	93	1.5	0.23	2.95	4.40	2.89	0.94	0.91	5.2 ~ 7.9
70	69	102	102	1.5	0.24	2.84	4.23	2.78	1.25	1.22	6.6 ~ 11.0
76	74	111	110	1.5	0.24	2.79	4.15	2.73	1.72	1.67	8.5 ~ 14.2
82	79	116	116	1.5	0.22	3.01	4.48	2.94	1.78	1.73	9.6 ~ 16.0
86	84	121	121	1.5	0.22	3.14	4.67	3.07	1.88	1.83	9.9 ~ 16.4
93	91	131	131	2	0.22	3.14	4.67	3.07	2.32	2.27	12.2 ~ 20.3
98	96	140	140	2	0.22	3.07	4.57	3.00	2.90	2.83	16.9 ~ 28.1
103	101	149	147	2	0.23	2.90	4.31	2.83	3.68	3.59	20.4 ~ 34.1
115	112	168	165	2.1	0.24	2.84	4.23	2.78	5.40	5.25	28.8 ~ 48.0
127	122	188	183	2.1	0.25	2.69	4.00	2.63	7.79	7.58	41.6 ~ 69.3
138	132	203	197	2.1	0.25	2.74	4.08	2.68	9.76	9.48	52.8 ~ 88.0
148	144	216	211	3	0.25	2.69	4.00	2.63	11.9	11.6	62.6 ~ 104.4

Table 1. Installation of Sealed Tapered Bore Spherical Roller Bearings

Units : mm

Nominal Bore Diameter d		Reduction of Radial Internal Clearance		Axial Displacement Drive up		Minimum Allowable Residual Clearance		
over	incl.	min.	max.	min.	max.	CN	C3	C4
24	30	0.010	0.015	0.15	0.20	0.015	0.025	0.040
30	40	0.015	0.020	0.25	0.30	0.015	0.030	0.045
40	50	0.020	0.025	0.35	0.40	0.020	0.035	0.055
50	65	0.025	0.030	0.40	0.45	0.025	0.045	0.065
65	80	0.035	0.040	0.50	0.60	0.030	0.055	0.080
80	100	0.040	0.050	0.60	0.70	0.030	0.060	0.090
100	120	0.055	0.065	0.80	0.90	0.035	0.070	0.105
120	130	0.065	0.075	0.90	1.00	0.045	0.085	0.125

Triple-Sealed Bearings for Bearing Units

Bearing Number

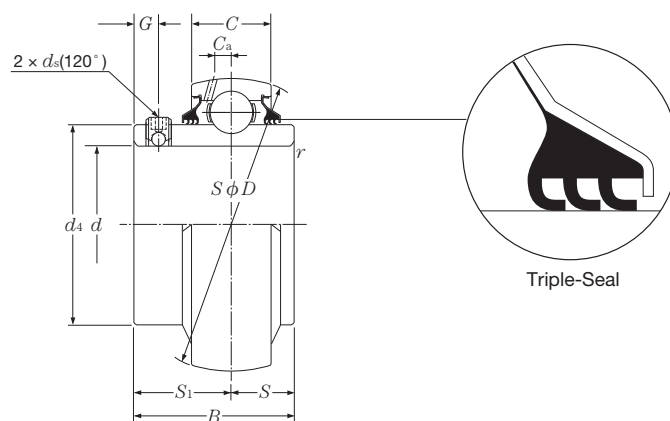
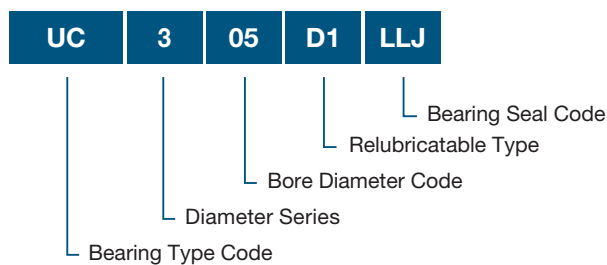

Shaft Diameter mm	Bearing Numbers	Nominal Dimensions											Basic Dynamic Load Rating kN	Basic Static Load Rating kN	Factor <i>f_o</i>	Mass kg (approx.)
		<i>d</i>	<i>D</i>	<i>B</i>	<i>C</i>	<i>r_{s min}</i> ^①	<i>S</i>	<i>S₁</i>	<i>G</i>	<i>ds</i>	<i>Ca</i>	<i>d₄</i>				
12	UC201D1LLJ	12	47	31	17	0.6	12.7	18.3	4.5	M 5 × 0.8	3.8	29.6	12.8	6.65	13.2	0.21
15	UC202D1LLJ	15	47	31	17	0.6	12.7	18.3	4.5	M 5 × 0.8	3.8	29.6	12.8	6.65	13.2	0.20
17	UC203D1LLJ	17	47	31	17	0.6	12.7	18.3	4.5	M 5 × 0.8	3.8	29.6	12.8	6.65	13.2	0.18
20	UC204D1LLJ	20	47	31	17	1	12.7	18.3	4.5	M 5 × 0.8	3.8	29.6	12.8	6.65	13.2	0.17
25	UC205D1LLJ	25	52	34.1	17	1	14.3	19.8	5	M 5 × 0.8	4	33.9	14.0	7.85	13.9	0.20
30	UC206D1LLJ	30	62	38.1	19	1	15.9	22.2	5	M 6 × 0.75	4.9	40.8	19.5	11.3	13.8	0.32
35	UC207D1LLJ	35	72	42.9	20	1.5	17.5	25.4	6	M 6 × 0.75	5.4	46.8	25.7	15.3	13.8	0.46
40	UC208D1LLJ	40	80	49.2	21	1.5	19	30.2	8	M 8 × 1	6	53	29.1	17.8	14.0	0.64
45	UC209D1LLJ	45	85	49.2	22	1.5	19	30.2	8	M 8 × 1	6.1	57.5	32.5	20.4	14.1	0.68
50	UC210D1LLJ	50	90	51.6	24	1.5	19	32.6	9	M 8 × 1	6.1	62.4	35.0	23.2	14.4	0.78
55	UC211D1LLJ	55	100	55.6	25	2	22.2	33.4	9	M 8 × 1	6.5	69	43.5	29.2	14.3	1.04
60	UC212D1LLJ	60	110	65.1	27	2	25.4	39.7	10	M10 × 1.25	7.3	77	52.5	36.0	14.3	1.46
65	UC213D1LLJ	65	120	65.1	32	2	25.4	39.7	10	M10 × 1.25	7.3	82.5	57.5	40.0	14.4	1.86
70	UC214D1LLJ	70	125	74.6	33	2	30.2	44.4	12	M10 × 1.25	7.7	87	62.0	44.0	14.5	2.10
75	UC215D1LLJ	75	130	77.8	34	2	33.3	44.5	12	M10 × 1.25	8	93	66.0	49.5	14.7	2.34
80	UC216D1LLJ	80	140	82.6	35	2.5	33.3	49.3	12	M10 × 1.25	8	98.1	72.5	53.0	14.6	2.78
85	UC217D1LLJ	85	150	85.7	36	2.5	34.1	51.6	12	M12 × 1.5	7.9	106.4	83.5	64.0	14.7	3.54
90	UC218D1LLJ	90	160	96	37	2.5	39.7	56.3	12	M12 × 1.5	8.7	111.6	96.0	71.5	14.5	4.40

① Smallest allowable dimension for chamfer dimension *r*.

Note 1. For shaft tolerances, see the "Bearing Units" catalog CAT.No.2400.

2. The precision of ball bearings is as specified in JIS B 1558 "Ball bearings for rolling bearing units."

3. Contact NTN Engineering for information on tapered bore shapes or ball bearings with bores diameters in inches.

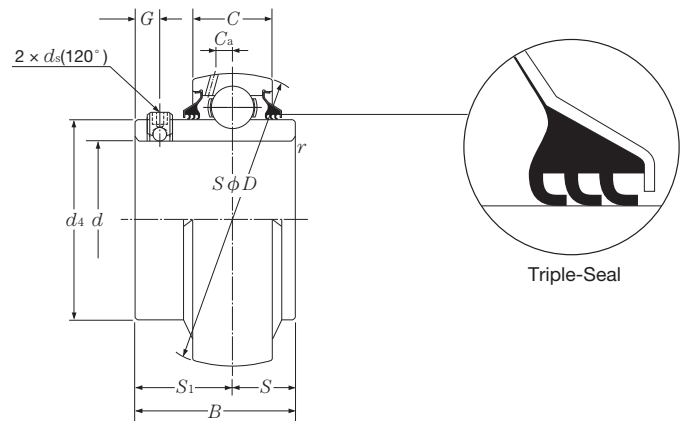

Shaft Diameter mm	Bearing Numbers	Nominal Dimensions											Basic Dynamic Load Rating kN	Basic Static Load Rating kN	Factor f_o	Mass kg (approx.)
		d	D	B	C	$r_{s \min}^{\text{①}}$	S	S_1	G	ds	C_a	d_4				
25	UC305D1LLJ	25	62	38	20	1.5	15	23	6	M 6 × 0.75	5	36.8	21.2	10.9	12.6	0.35
30	UC306D1LLJ	30	72	43	23	1.5	17	26	6	M 6 × 0.75	5.6	44.9	26.7	15.0	13.3	0.56
35	UC307D1LLJ	35	80	48	25	2	19	29	8	M 8 × 1	5.7	49.4	33.5	19.1	13.1	0.70
40	UC308D1LLJ	40	90	52	27	2	19	33	10	M10 × 1.25	6.1	56	40.5	24.0	13.2	0.96
45	UC309D1LLJ	45	100	57	29	2	22	35	10	M10 × 1.25	7.1	63.5	53.0	32.0	13.1	1.28
50	UC310D1LLJ	50	110	61	32	2.5	22	39	12	M12 × 1.5	7.9	70.6	62.0	38.5	13.2	1.68
55	UC311D1LLJ	55	120	66	34	2.5	25	41	12	M12 × 1.5	8.5	76.6	71.5	45.0	13.2	2.08
60	UC312D1LLJ	60	130	71	36	2.5	26	45	12	M12 × 1.5	9	82.7	82.0	52.0	13.2	2.62
65	UC313D1LLJ	65	140	75	39	2.5	30	45	12	M12 × 1.5	9.4	88.2	92.5	60.0	13.2	3.22
70	UC314D1LLJ	70	150	78	41	2.5	33	45	12	M12 × 1.5	10	94.8	104	68.0	13.2	3.86
75	UC315D1LLJ	75	160	82	43	2.5	32	50	14	M14 × 1.5	10.5	101.3	113	77.0	13.2	4.70
80	UC316D1LLJ	80	170	86	45	2.5	34	52	14	M14 × 1.5	11.1	107.9	123	86.5	13.3	5.60
85	UC317D1LLJ	85	180	96	47	3	40	56	16	M16 × 1.5	11.5	114.4	133	97.0	13.3	6.70
90	UC318D1LLJ	90	190	96	49	3	40	56	16	M16 × 1.5	12.2	120.9	143	107	13.3	7.60
95	UC319D1LLJ	95	200	103	51	3	41	62	16	M16 × 1.5	12.7	127.5	153	119	13.3	8.70
100	UC320D1LLJ	100	215	108	55	3	42	66	18	M18 × 1.5	14	135.6	173	141	13.2	10.80

① Smallest allowable dimension for chamfer dimension r .

Note 1. For shaft tolerances, see the "Bearing Units" catalog CAT.No.2400

2. The precision of ball bearings is as specified in JIS B 1558 "Ball bearings for rolling bearing units."

3. Contact **NTN** Engineering for information on tapered bore shapes or ball bearings with bores diameters in inches.

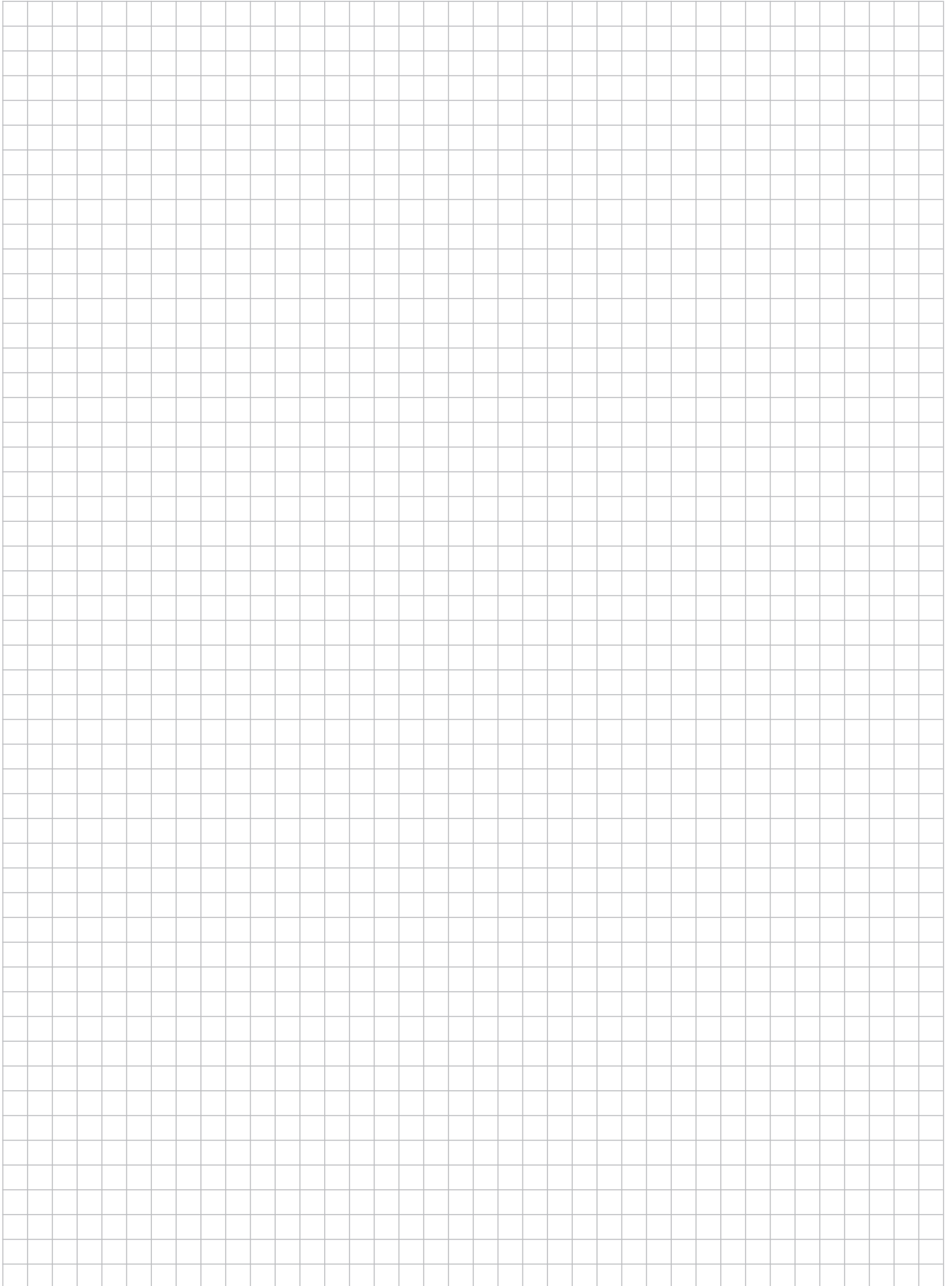

NTN®